

Problem-Driven Visualization Through Design Studies

Tamara Munzner

Department of Computer Science
University of British Columbia

 [@tamaramunzner](https://twitter.com/tamaramunzner)

ChinaVis 2020 Keynote

October 31 2020, virtual / Xi'an

<http://www.cs.ubc.ca/~tmm/talks.html#chinavis20>



Nested model: Four levels of visualization concerns

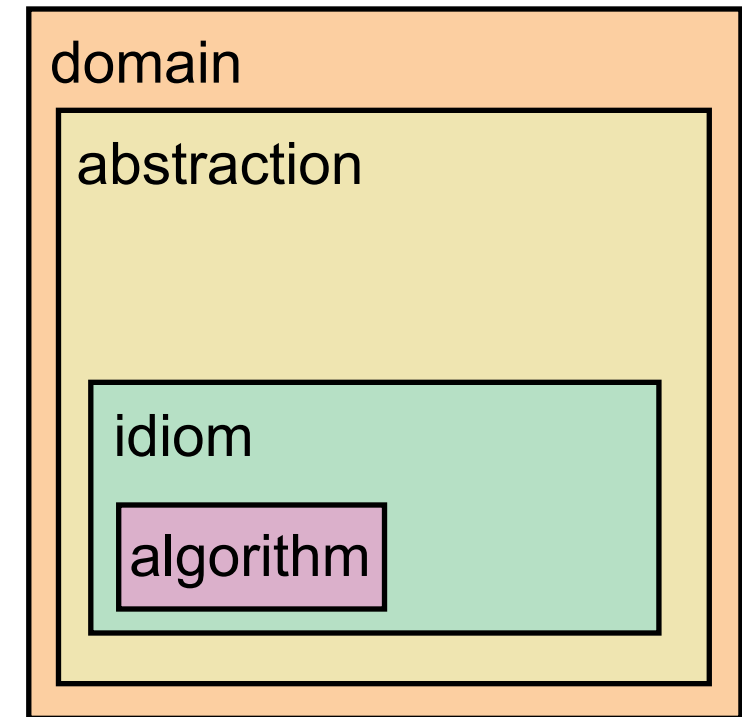

[A Nested Model of Visualization Design and Validation. Munzner. *IEEE TVCG* 15(6):921-928, 2009 (Proc. InfoVis 2009).]

Nested model: Four levels of visualization concerns

- *domain* situation
 - **who** are the target users?

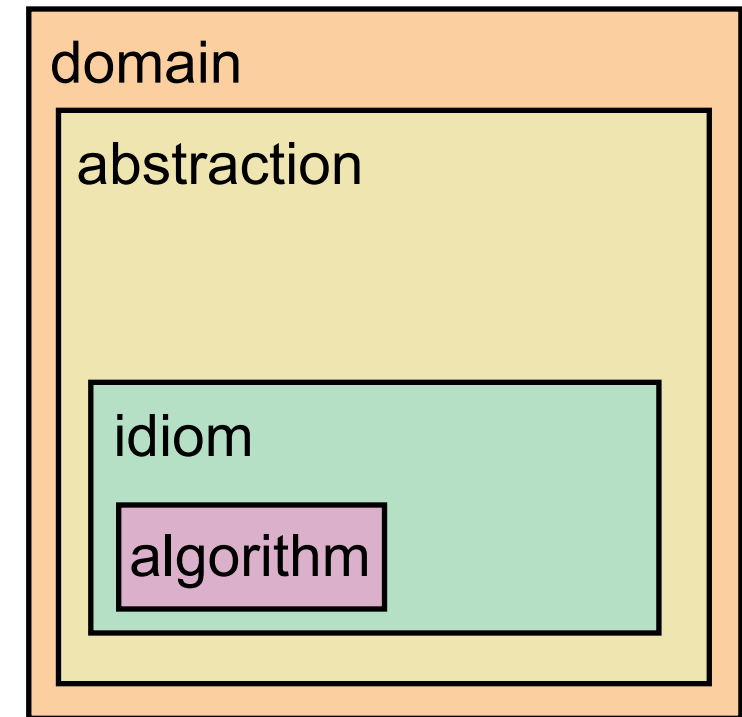

[A Nested Model of Visualization Design and Validation. Munzner. *IEEE TVCG* 15(6):921-928, 2009 (Proc. InfoVis 2009).]

Nested model: Four levels of visualization concerns

- *domain* situation
 - **who** are the target users?
- *abstraction*
 - translate from specifics of domain to vocabulary of vis

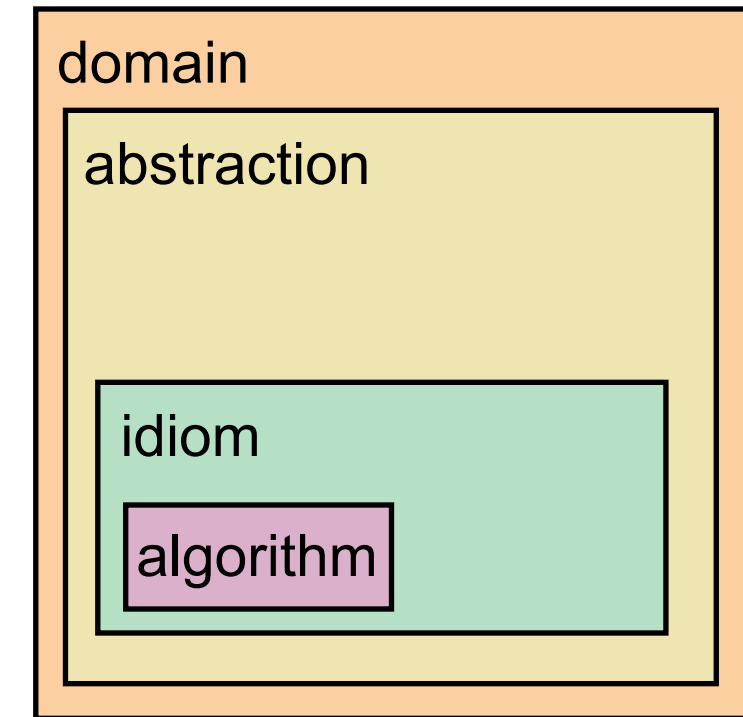

[A Nested Model of Visualization Design and Validation. Munzner. IEEE TVCG 15(6):921-928, 2009 (Proc. InfoVis 2009).]

Nested model: Four levels of visualization concerns

- *domain* situation
 - **who** are the target users?
- *abstraction*
 - translate from specifics of domain to vocabulary of vis
 - **what** is shown? **data abstraction**

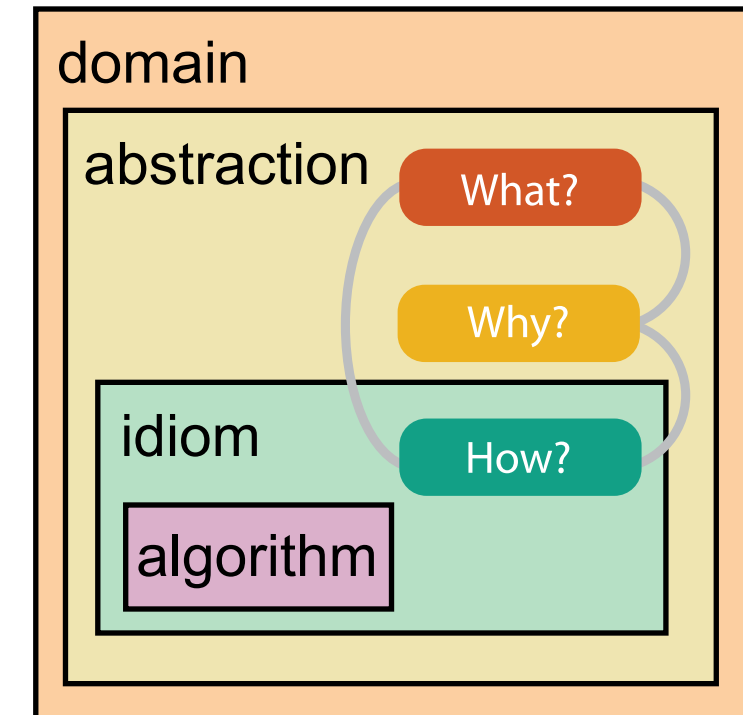

[A Nested Model of Visualization Design and Validation. Munzner. IEEE TVCG 15(6):921-928, 2009 (Proc. InfoVis 2009).]

[A Multi-Level Typology of Abstract Visualization Tasks Brehmer and Munzner. IEEE TVCG 19(12):2376-2385, 2013 (Proc. InfoVis 2013).]

Nested model: Four levels of visualization concerns

- *domain* situation
 - **who** are the target users?
- *abstraction*
 - translate from specifics of domain to vocabulary of vis
 - **what** is shown? **data abstraction**
 - often don't just draw what you're given: transform to new form

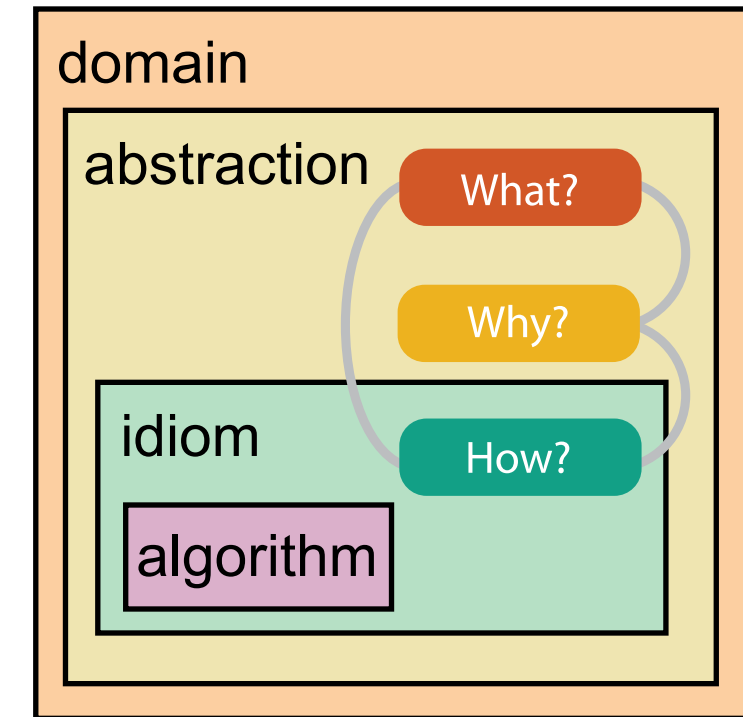

[A Nested Model of Visualization Design and Validation. Munzner. *IEEE TVCG* 15(6):921-928, 2009 (Proc. InfoVis 2009).]

[A Multi-Level Typology of Abstract Visualization Tasks Brehmer and Munzner. *IEEE TVCG* 19(12):2376-2385, 2013 (Proc. InfoVis 2013).]

Nested model: Four levels of visualization concerns

- *domain* situation
 - **who** are the target users?
- *abstraction*
 - translate from specifics of domain to vocabulary of vis
 - **what** is shown? **data abstraction**
 - often don't just draw what you're given: transform to new form
 - **why** is the user looking at it? **task abstraction**

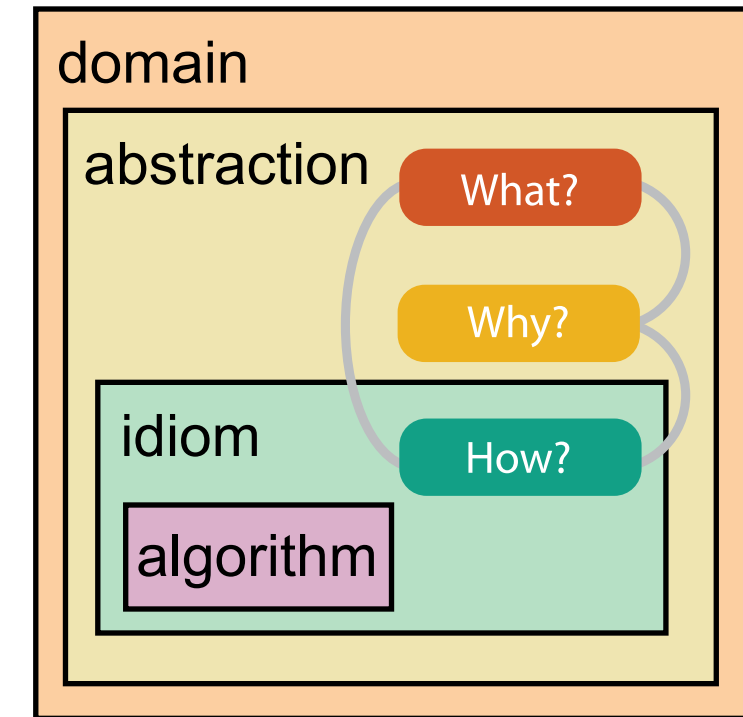

[A Nested Model of Visualization Design and Validation. Munzner. *IEEE TVCG* 15(6):921-928, 2009 (Proc. InfoVis 2009).]

[A Multi-Level Typology of Abstract Visualization Tasks Brehmer and Munzner. *IEEE TVCG* 19(12):2376-2385, 2013 (Proc. InfoVis 2013).]

Nested model: Four levels of visualization concerns

- *domain* situation
 - **who** are the target users?
- *abstraction*
 - translate from specifics of domain to vocabulary of vis
 - **what** is shown? **data abstraction**
 - often don't just draw what you're given: transform to new form
 - **why** is the user looking at it? **task abstraction**
- *idiom*
 - **how** is it shown?

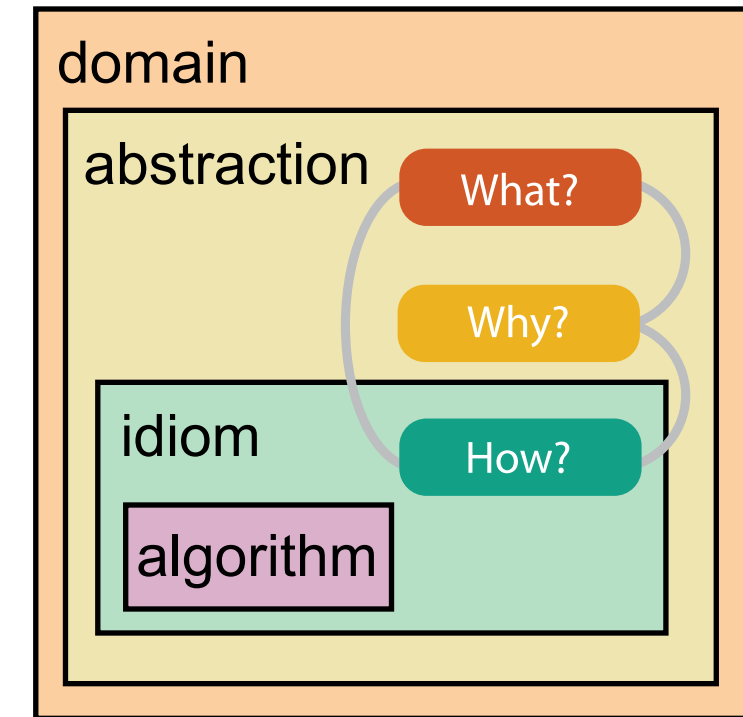

[A Nested Model of Visualization Design and Validation. Munzner. *IEEE TVCG* 15(6):921-928, 2009 (Proc. InfoVis 2009).]

[A Multi-Level Typology of Abstract Visualization Tasks Brehmer and Munzner. *IEEE TVCG* 19(12):2376-2385, 2013 (Proc. InfoVis 2013).]

Nested model: Four levels of visualization concerns

- *domain* situation
 - **who** are the target users?
- *abstraction*
 - translate from specifics of domain to vocabulary of vis
 - **what** is shown? **data abstraction**
 - often don't just draw what you're given: transform to new form
 - **why** is the user looking at it? **task abstraction**
- *idiom*
 - **how** is it shown?
 - **visual encoding idiom**: how to draw

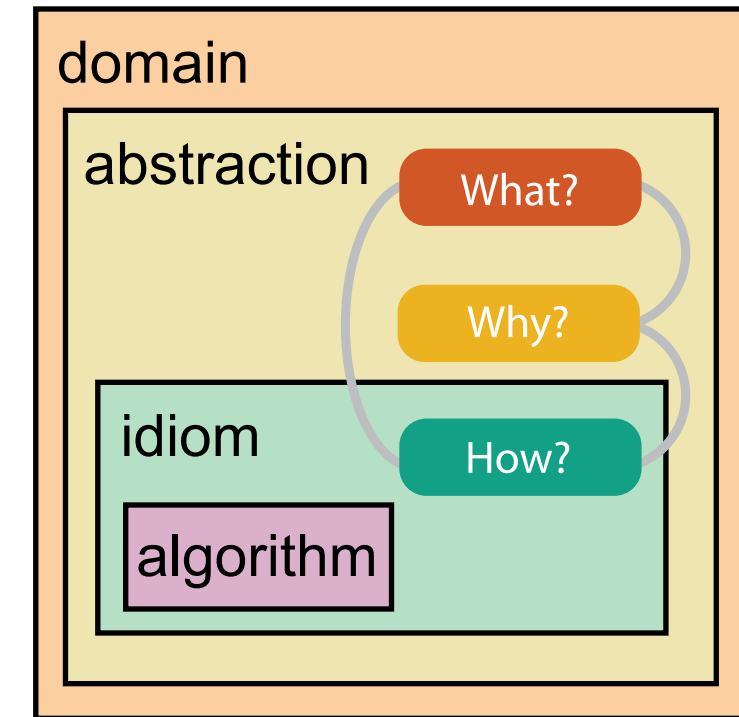

[A Nested Model of Visualization Design and Validation. Munzner. *IEEE TVCG* 15(6):921-928, 2009 (Proc. InfoVis 2009).]

[A Multi-Level Typology of Abstract Visualization Tasks Brehmer and Munzner. *IEEE TVCG* 19(12):2376-2385, 2013 (Proc. InfoVis 2013).]

Nested model: Four levels of visualization concerns

- *domain* situation
 - **who** are the target users?
- *abstraction*
 - translate from specifics of domain to vocabulary of vis
 - **what** is shown? **data abstraction**
 - often don't just draw what you're given: transform to new form
 - **why** is the user looking at it? **task abstraction**
- *idiom*
 - **how** is it shown?
 - **visual encoding idiom**: how to draw
 - **interaction idiom**: how to manipulate

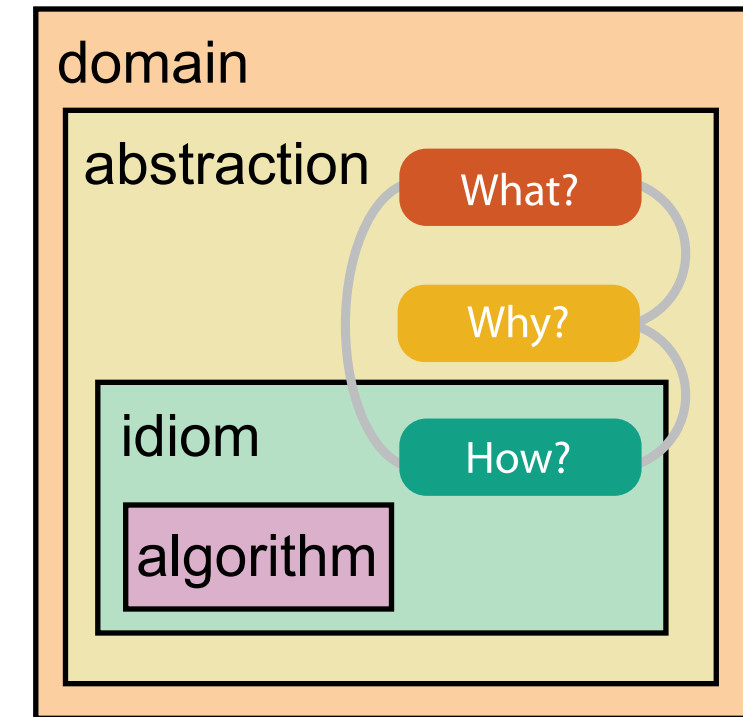

[A Nested Model of Visualization Design and Validation. Munzner. *IEEE TVCG* 15(6):921-928, 2009 (Proc. InfoVis 2009).]

[A Multi-Level Typology of Abstract Visualization Tasks Brehmer and Munzner. *IEEE TVCG* 19(12):2376-2385, 2013 (Proc. InfoVis 2013).]

Nested model: Four levels of visualization concerns

- *domain* situation
 - **who** are the target users?
- *abstraction*
 - translate from specifics of domain to vocabulary of vis
 - **what** is shown? **data abstraction**
 - often don't just draw what you're given: transform to new form
 - **why** is the user looking at it? **task abstraction**
- *idiom*
 - **how** is it shown?
 - **visual encoding idiom**: how to draw
 - **interaction idiom**: how to manipulate
- *algorithm*
 - efficient computation

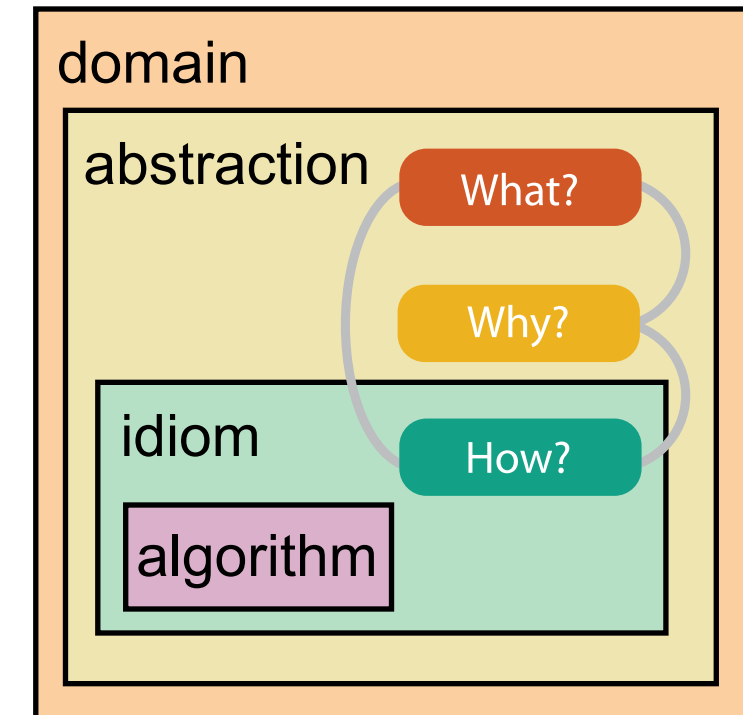

[A Nested Model of Visualization Design and Validation. Munzner. *IEEE TVCG* 15(6):921-928, 2009 (Proc. InfoVis 2009).]

[A Multi-Level Typology of Abstract Visualization Tasks Brehmer and Munzner. *IEEE TVCG* 19(12):2376-2385, 2013 (Proc. InfoVis 2013).]

Why is validation difficult?

- different ways to get it wrong at each level

[A Nested Model of Visualization Design and Validation. Munzner. IEEE TVCG 15(6):921-928, 2009 (Proc. InfoVis 2009).]

Why is validation difficult?

- different ways to get it wrong at each level



Domain situation

You misunderstood their needs

[A Nested Model of Visualization Design and Validation. Munzner. IEEE TVCG 15(6):921-928, 2009 (Proc. InfoVis 2009).]

Why is validation difficult?

- different ways to get it wrong at each level

Domain situation

You misunderstood their needs

Data/task abstraction

You're showing them the wrong thing

[A Nested Model of Visualization Design and Validation. Munzner. IEEE TVCG 15(6):921-928, 2009 (Proc. InfoVis 2009).]

Why is validation difficult?

- different ways to get it wrong at each level

 **Domain situation**
You misunderstood their needs

 **Data/task abstraction**
You're showing them the wrong thing

 **Visual encoding/interaction idiom**
The way you show it doesn't work

[A Nested Model of Visualization Design and Validation. Munzner. IEEE TVCG 15(6):921-928, 2009 (Proc. InfoVis 2009).]

Why is validation difficult?

- different ways to get it wrong at each level

 **Domain situation**
You misunderstood their needs

 **Data/task abstraction**
You're showing them the wrong thing

 **Visual encoding/interaction idiom**
The way you show it doesn't work

 **Algorithm**
Your code is too slow

[A Nested Model of Visualization Design and Validation. Munzner. IEEE TVCG 15(6):921-928, 2009 (Proc. InfoVis 2009).]

Validation solution: use methods from appropriate fields at each level

Validation solution: use methods from appropriate fields at each level

computer
science



Algorithm

Measure system time/memory

Analyze computational complexity

Validation solution: use methods from appropriate fields at each level

computer
science



technique-driven
work

Validation solution: use methods from appropriate fields at each level

design

 **Visual encoding/interaction idiom**
Justify design with respect to alternatives

computer
science

 **Algorithm**
Measure system time/memory
Analyze computational complexity

cognitive
psychology

Analyze results qualitatively
Measure human time with lab experiment (*lab study*)



technique-driven
work

Validation solution: use methods from appropriate fields at each level

anthropology/
ethnography

 **Domain situation**
Observe target users using existing tools

 **Data/task abstraction**

design

 **Visual encoding/interaction idiom**
Justify design with respect to alternatives

computer
science

 **Algorithm**
Measure system time/memory
Analyze computational complexity

cognitive
psychology

Analyze results qualitatively
Measure human time with lab experiment (*lab study*)

anthropology/
ethnography

Observe target users after deployment (*field study*)
Measure adoption

technique-driven
work

Validation solution: use methods from appropriate fields at each level

anthropology/
ethnography

 **Domain situation**
Observe target users using existing tools

 **Data/task abstraction**

 **Visual encoding/interaction idiom**
Justify design with respect to alternatives

design

computer
science

 **Algorithm**
Measure system time/memory
Analyze computational complexity

cognitive
psychology

Analyze results qualitatively
Measure human time with lab experiment (*lab study*)

anthropology/
ethnography

Observe target users after deployment (*field study*)

Measure adoption

problem-driven
work



technique-driven
work

Validation solution: use methods from appropriate fields at each level

- avoid mismatches between level and validation

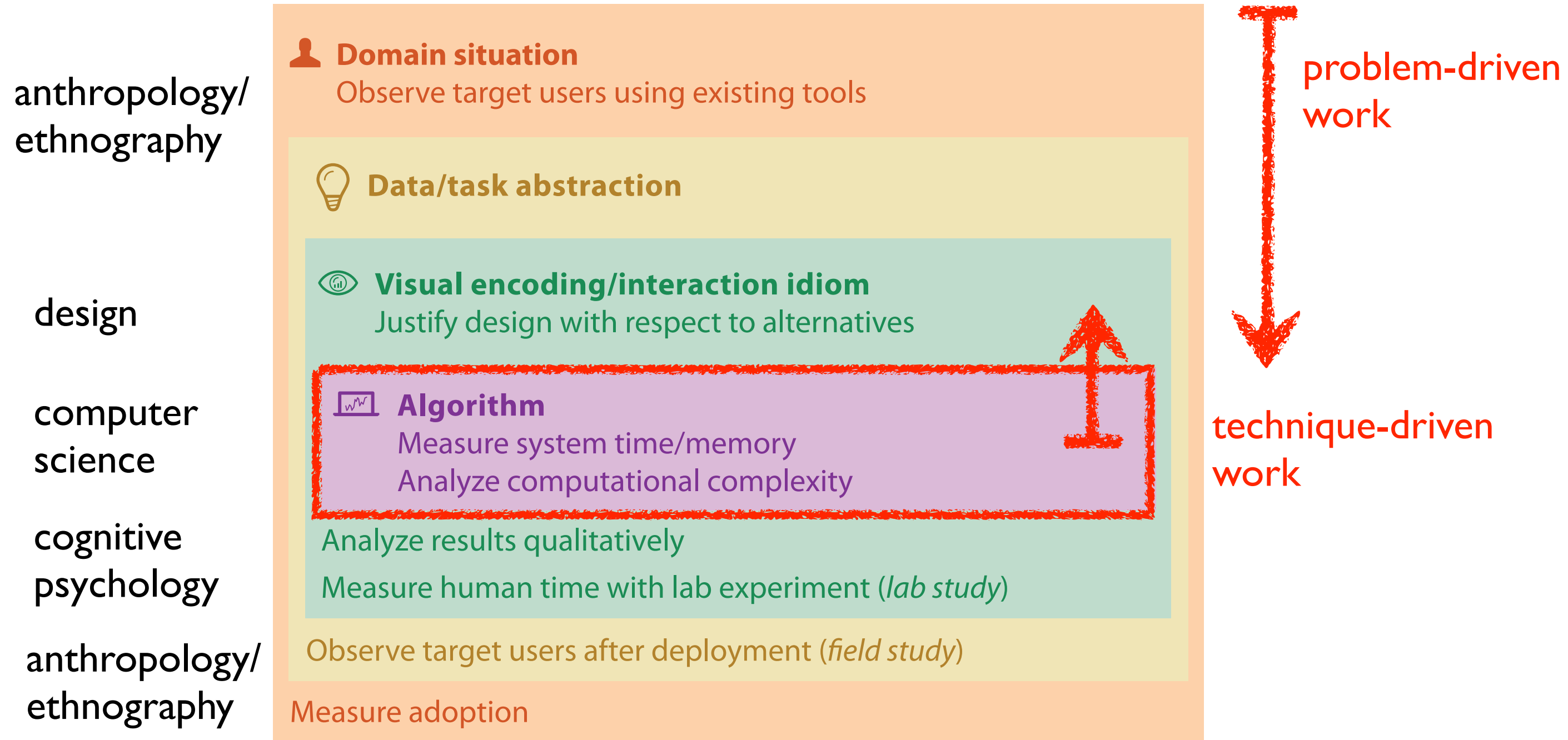

Visualization: Angles of attack

**problem-
driven work**

Visualization: Angles of attack

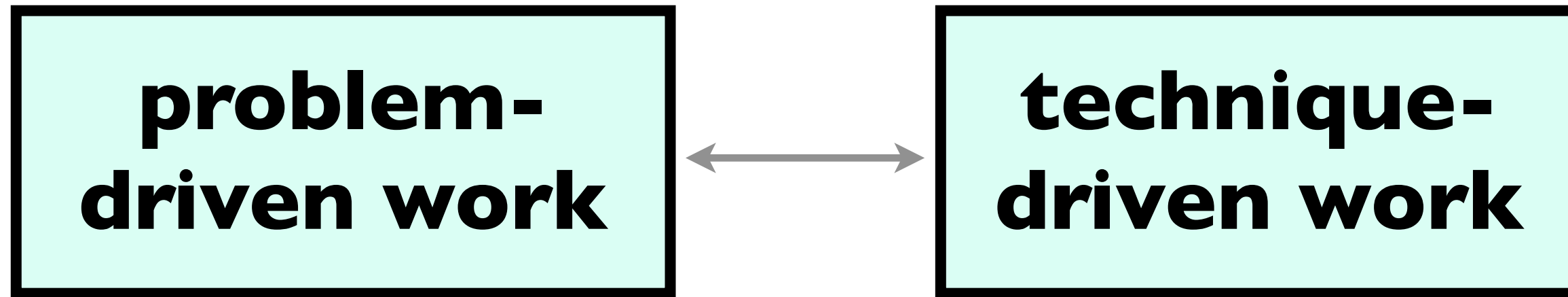

Visualization: Angles of attack

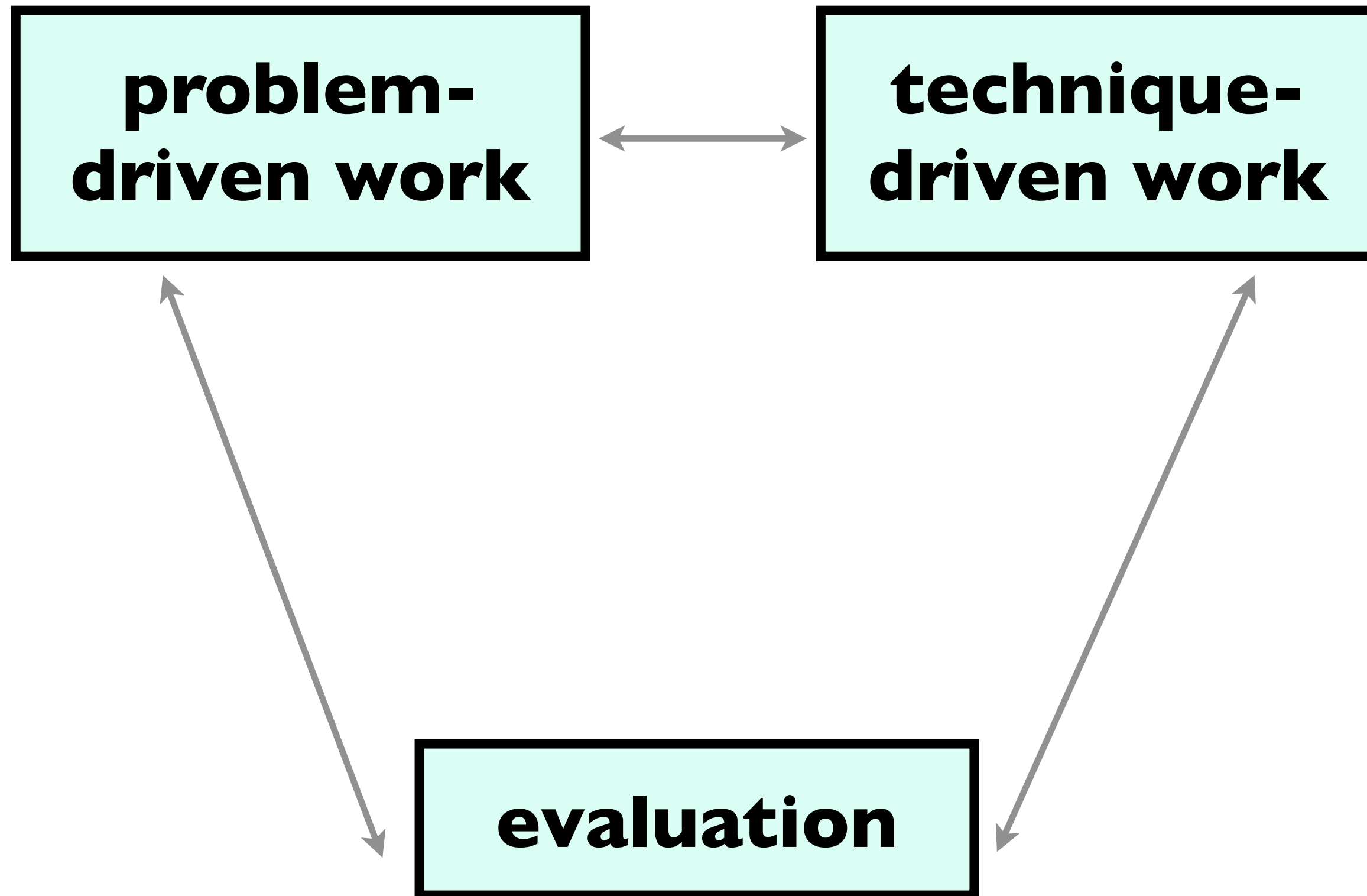

Visualization: Angles of attack

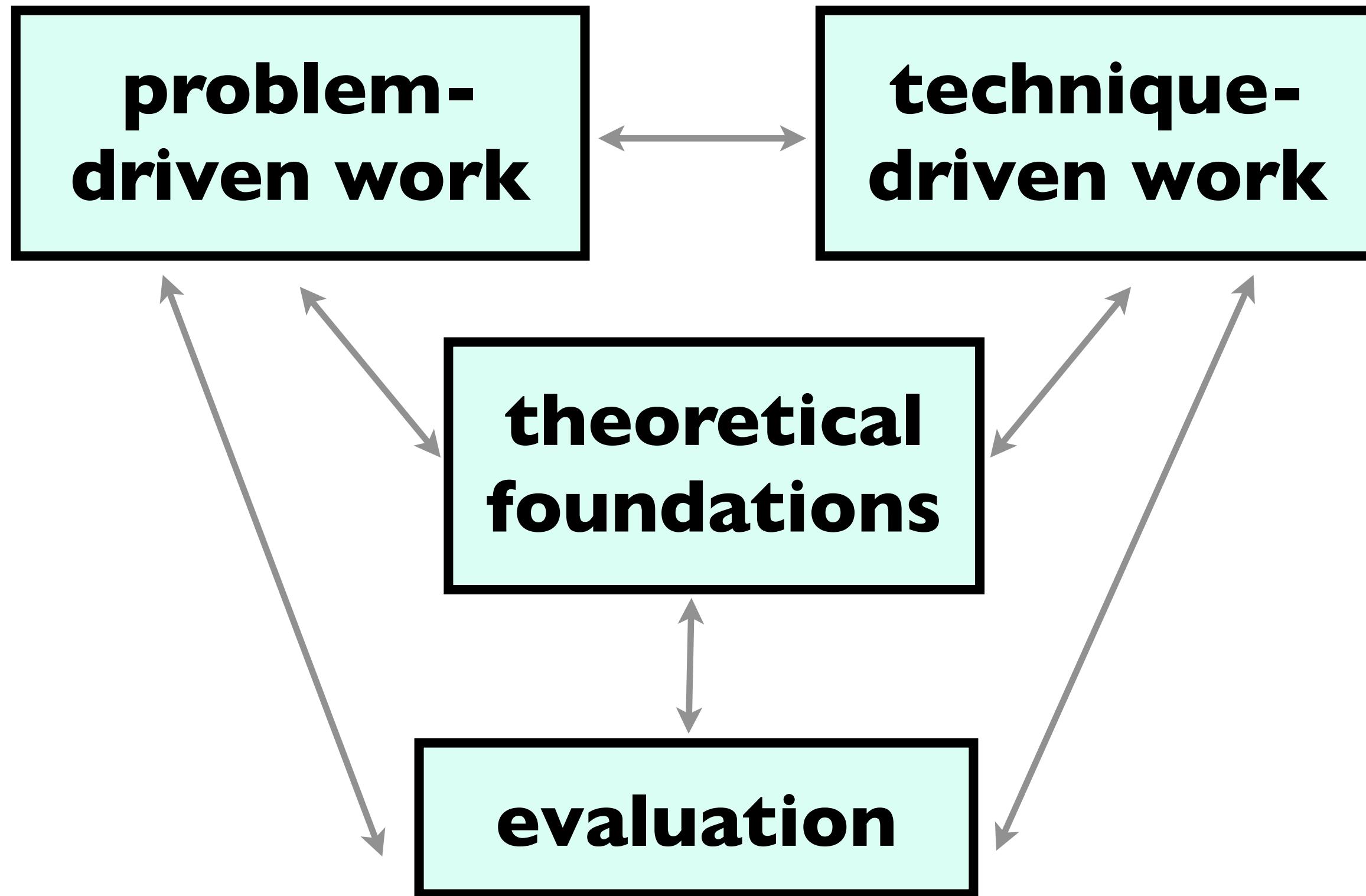

Visualization: Angles of attack

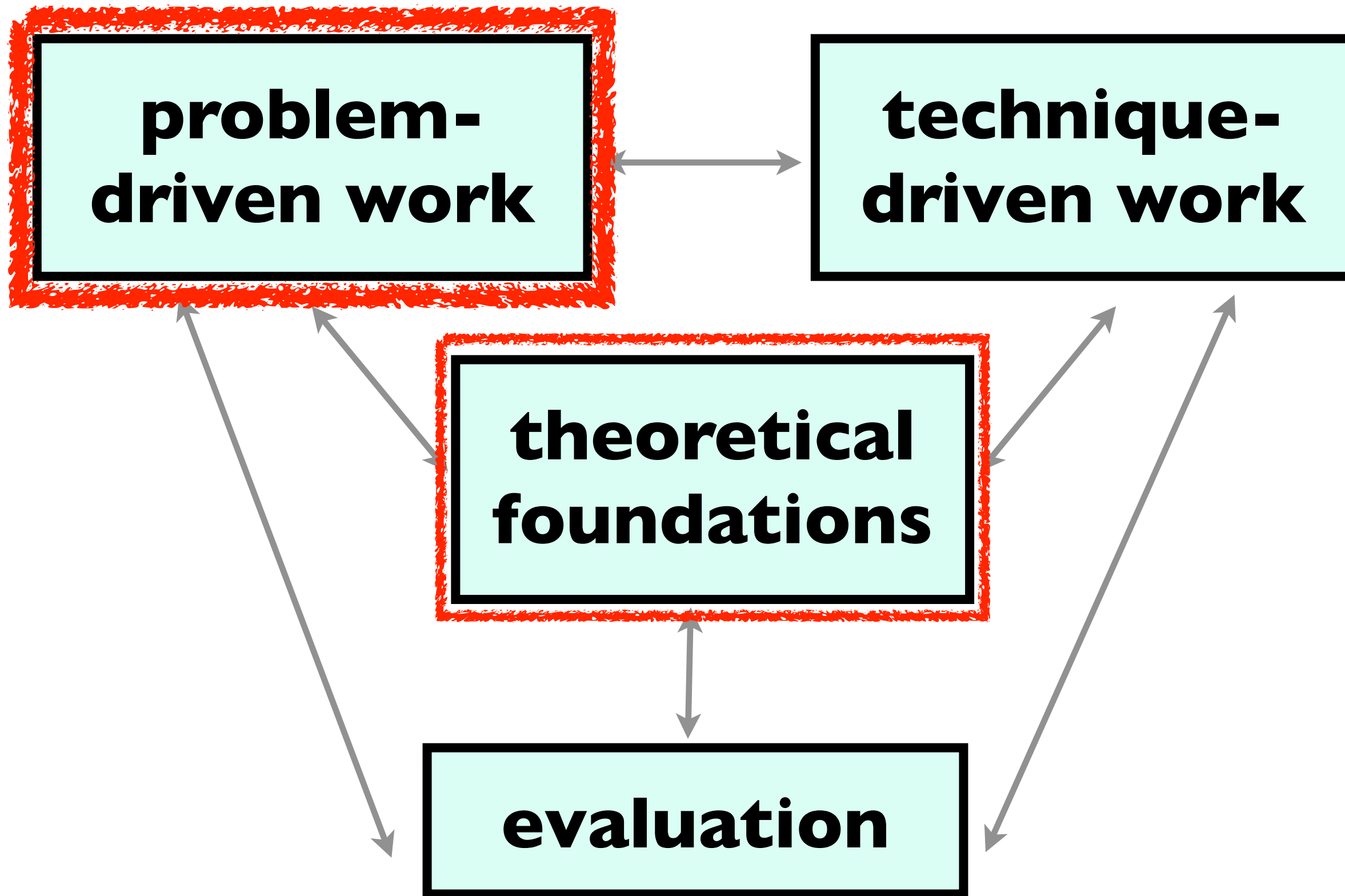

Problem-driven visualization: Design studies

Problem driven visualization: Design studies

“A design study is a project in which visualization researchers analyze a specific real-world problem faced by domain experts...”

Problem driven visualization: Design studies

“A design study is a project in which visualization researchers analyze a specific real-world problem faced by domain experts, design a visualization system that supports solving this problem...”

Problem driven visualization: Design studies

“A design study is a project in which visualization researchers analyze a specific real-world problem faced by domain experts, design a visualization system that supports solving this problem, validate the design, and reflect about lessons learned in order to refine visualization design guidelines.”

*[Design Study Methodology: Reflections from the Trenches and the Stacks.
Sedlmair, Meyer & Munzner. IEEE TVCG 18(12): 2431-2440, 2012 (Proc. InfoVis 2012).]*

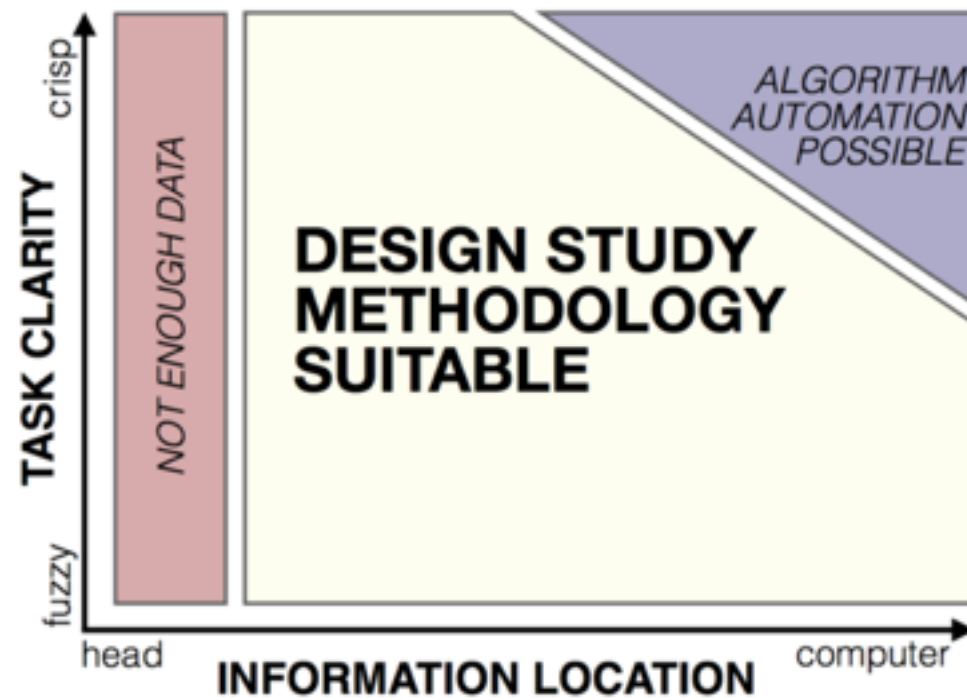

Michael Sedlmair



Miriah Meyer



Design Study Methodology

Reflections from the Trenches and from the Stacks

<http://www.cs.ubc.ca/labs/imager/tr/2012/dsm/>

Design Study Methodology: Reflections from the Trenches and from the Stacks.

Sedlmair, Meyer, Munzner. *IEEE Trans. Visualization and Computer Graphics* 18(12): 2431-2440, 2012 (Proc. InfoVis 2012).

Lessons learned from the trenches: 20+ between us

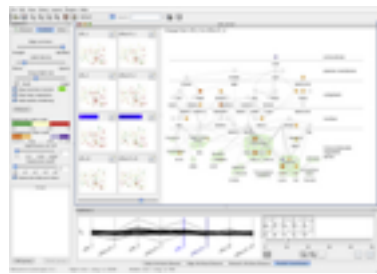

Cerebral
genomics

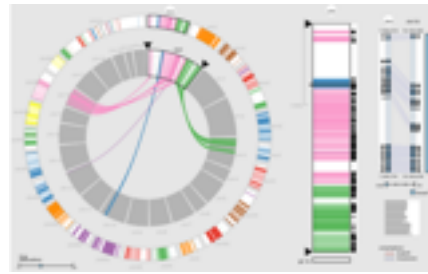

MizBee
genomics

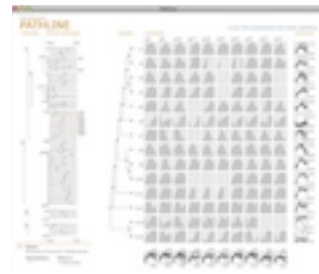

Pathline
genomics

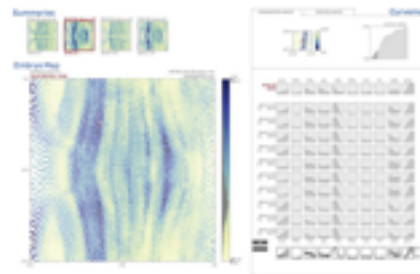

MulteeSum
genomics

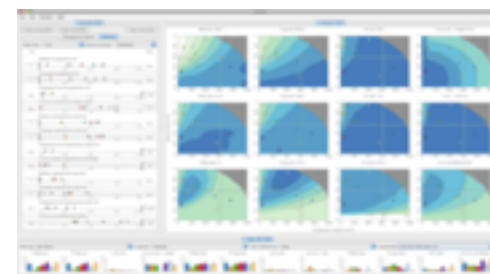

Vismon
fisheries management

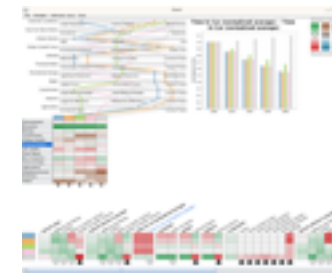

QuestVis
sustainability



WiKeVis
in-car networks



MostVis
in-car networks

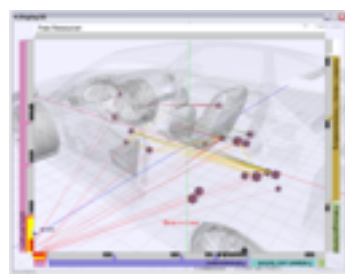

Car-X-Ray
in-car networks



ProgSpy2010
in-car networks



ReEx
in-car networks



Cardiogram
in-car networks



AutobahnVis
in-car networks

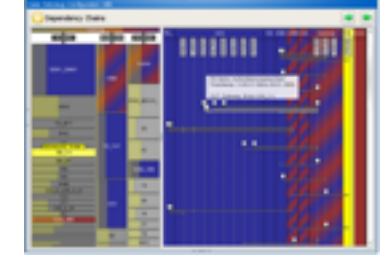

VisTra
in-car networks



Constellation
linguistics

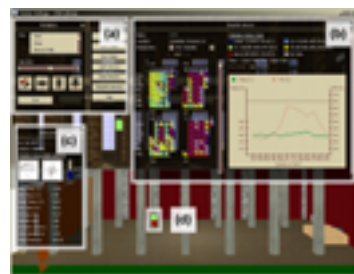

LibVis
cultural heritage

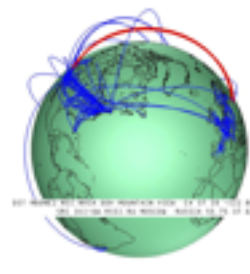

Caidants
multicast



SessionViewer
web log analysis

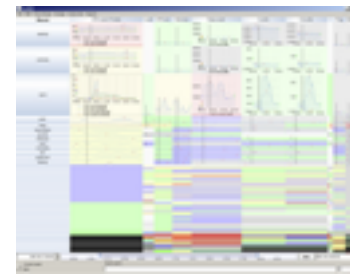

LiveRAC
server hosting

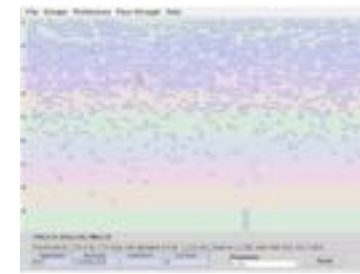

PowerSetViewer
data mining

Design study methodology: definitions



Design study methodology: definitions

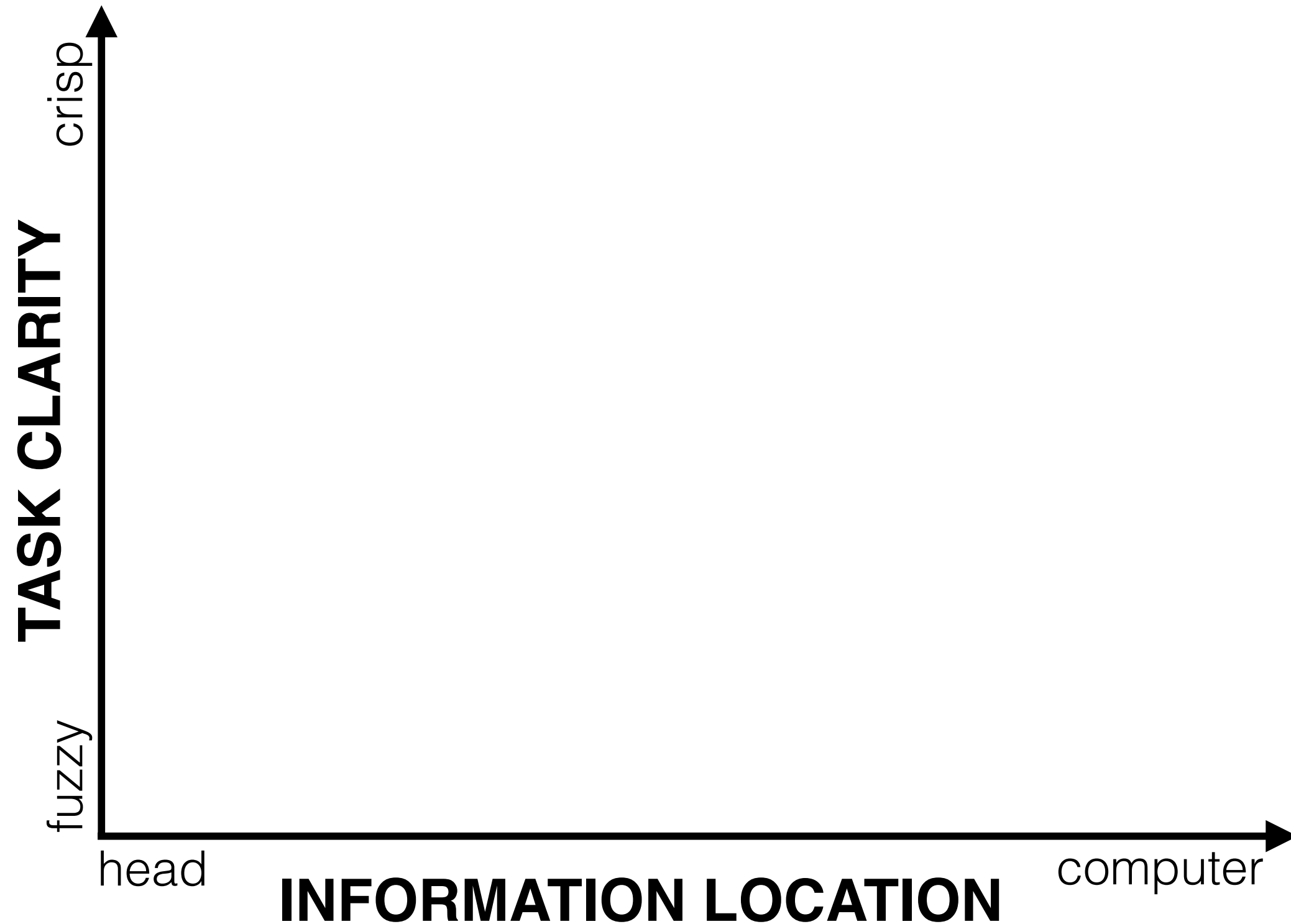

Design study methodology: definitions

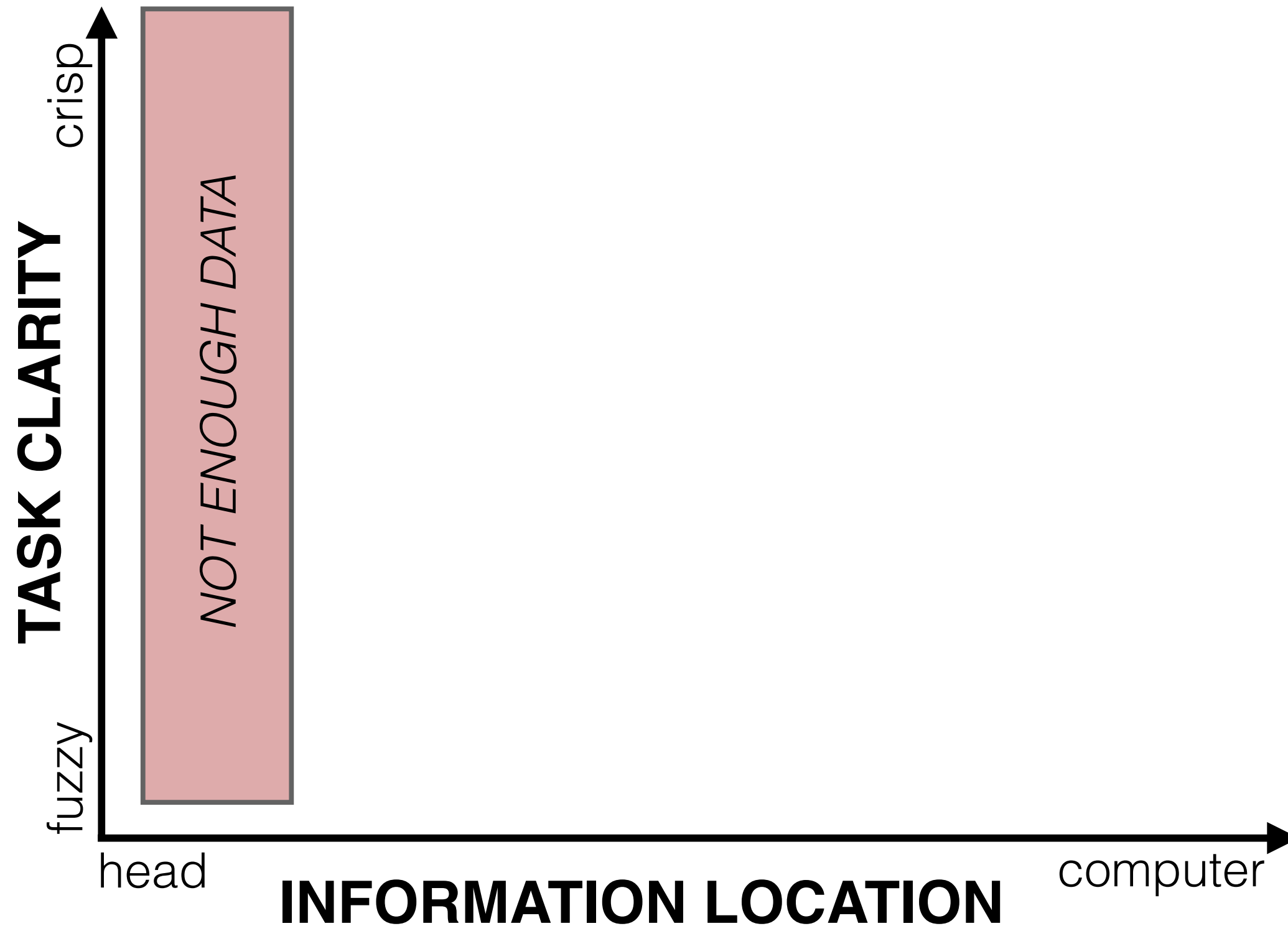

Design study methodology: definitions

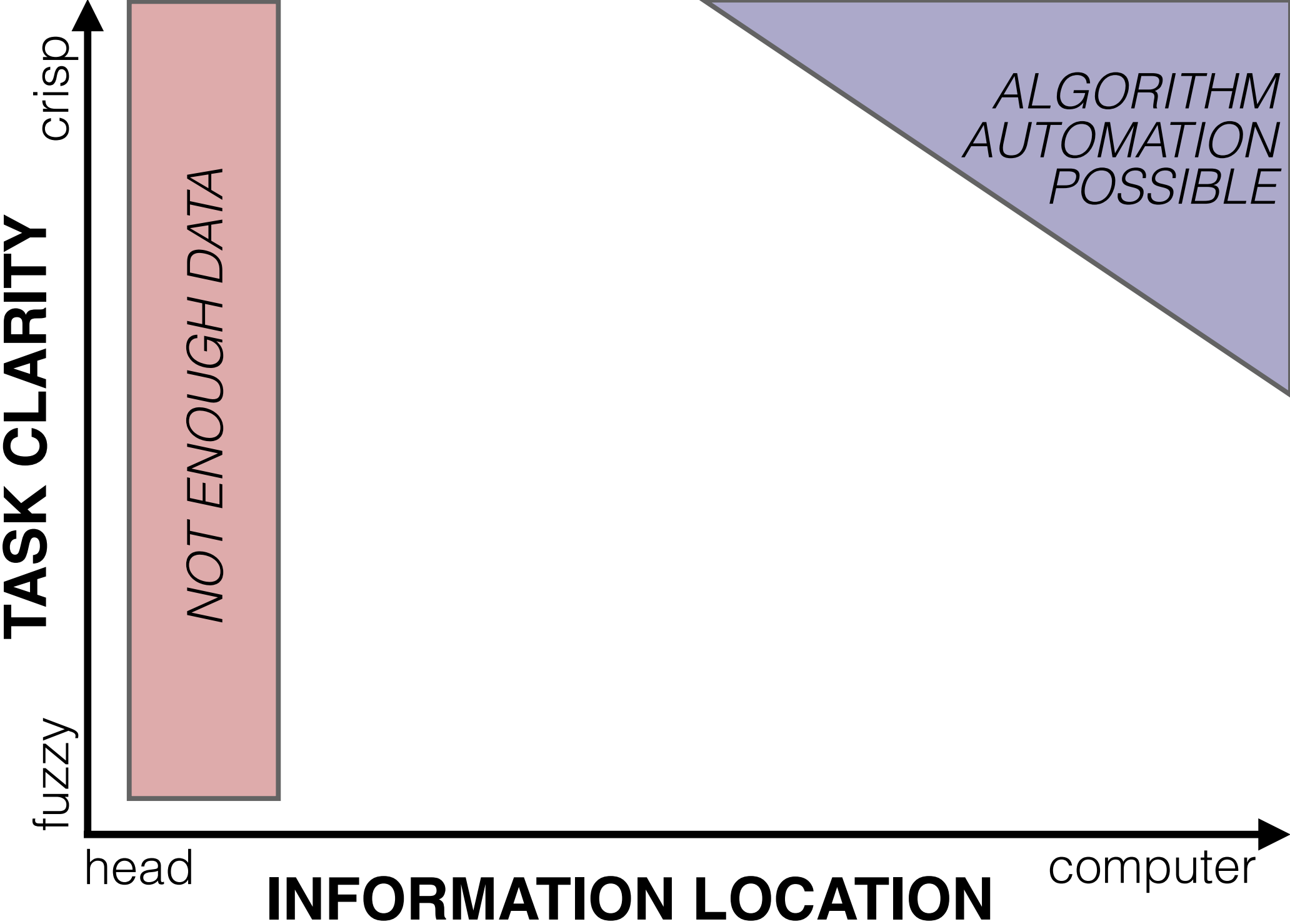

[Design Study Methodology: Reflections from the Trenches and the Stacks. Sedlmair, Meyer & Munzner. IEEE TVCG 18(12): 2431-2440, 2012 (Proc. InfoVis 2012).]

Design study methodology: definitions

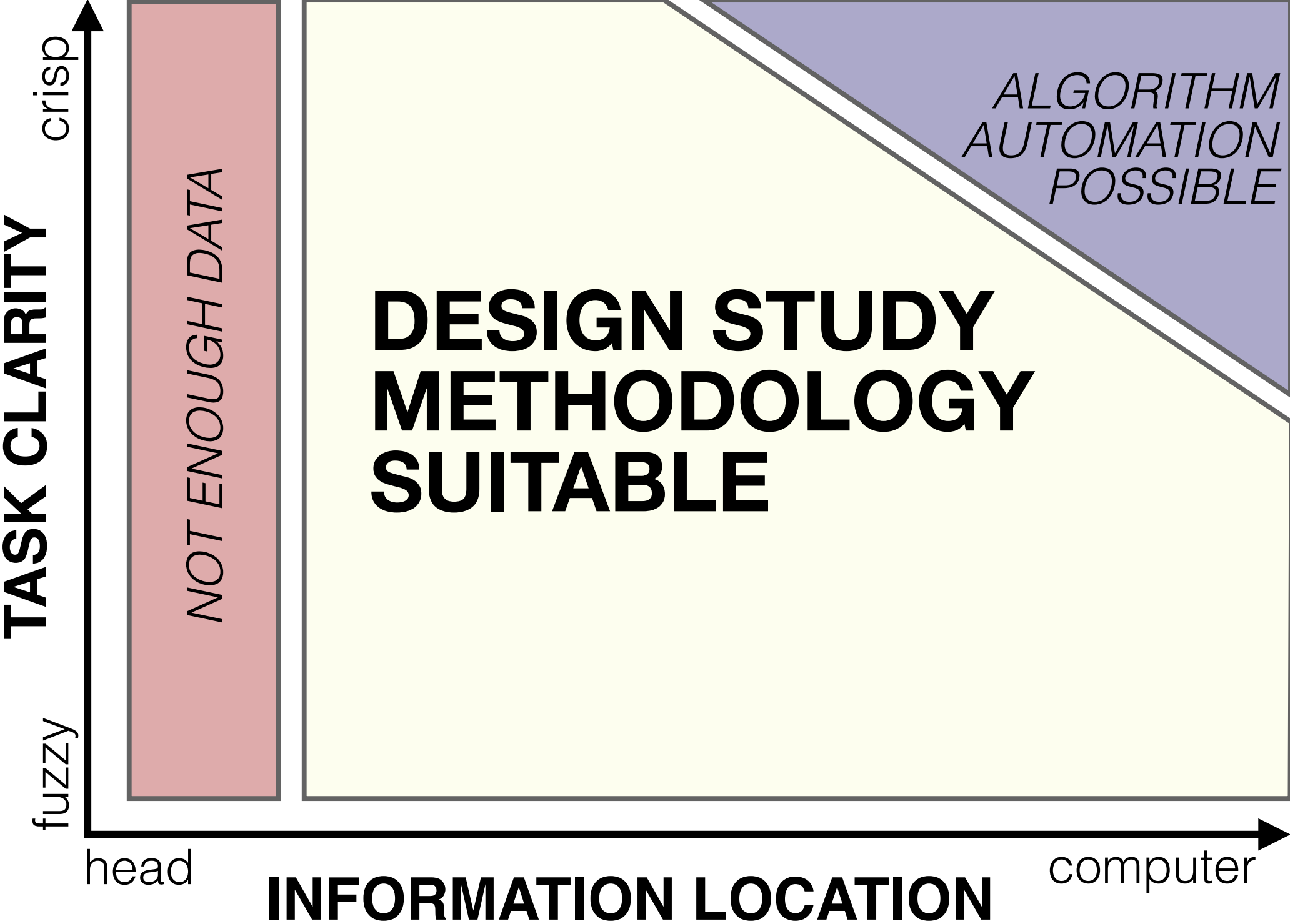

[Design Study Methodology: Reflections from the Trenches and the Stacks. Sedlmair, Meyer & Munzner. IEEE TVCG 18(12): 2431-2440, 2012 (Proc. InfoVis 2012).]

9-stage framework

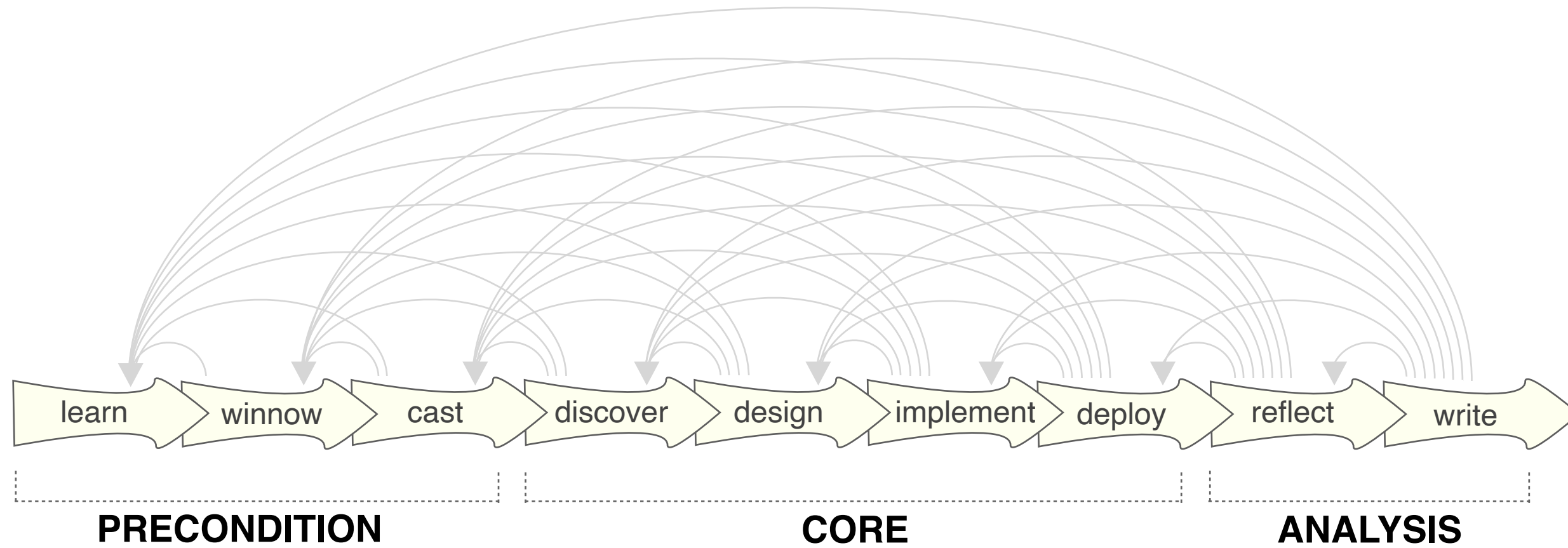

9-stage framework

learn
winnow
cast

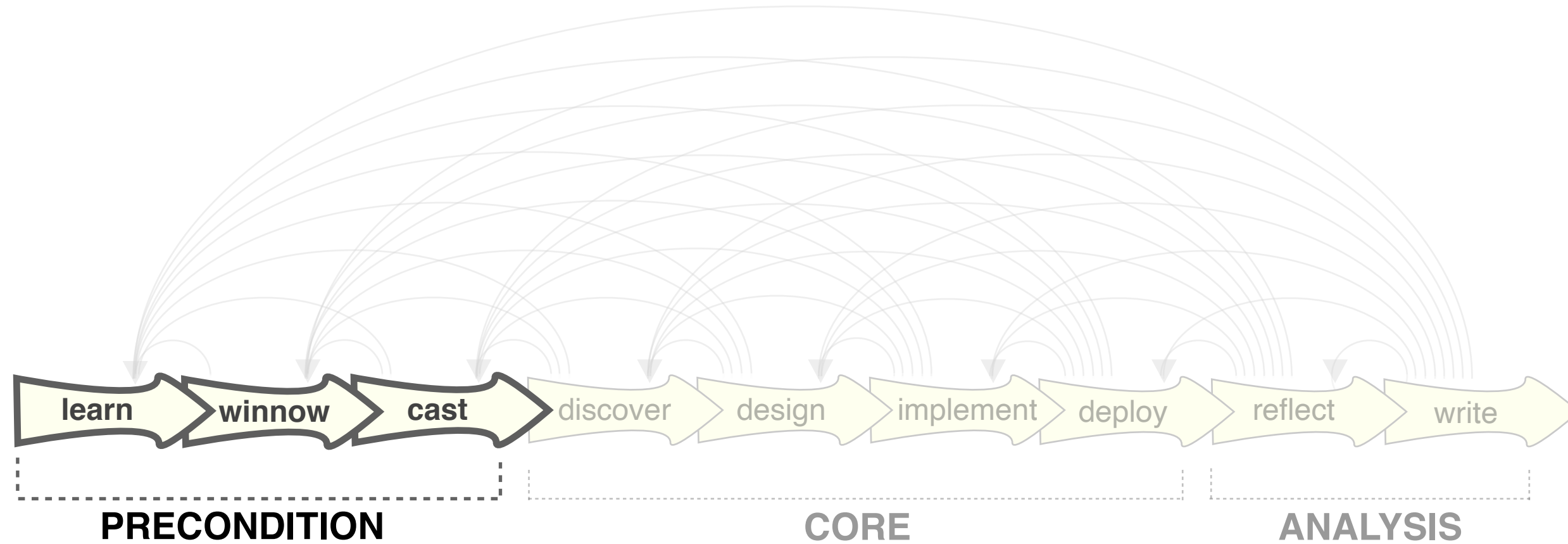

9-stage framework

discover
design
implement
deploy

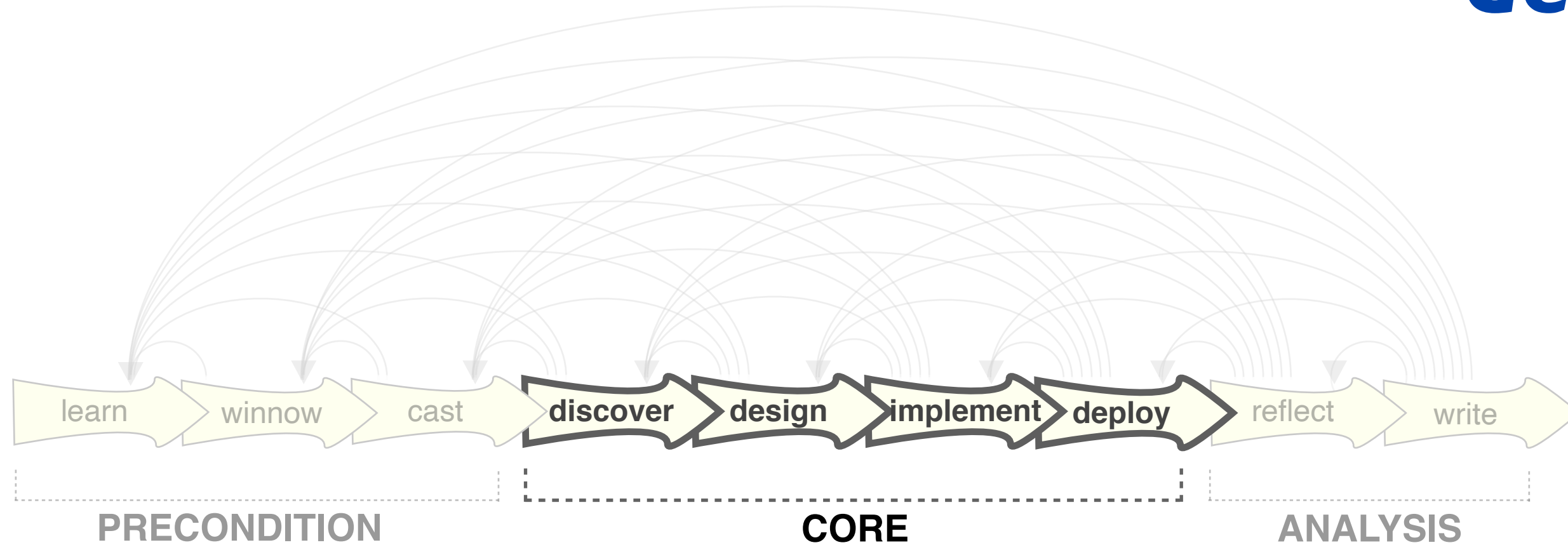

9-stage framework

- guidelines: confirm, refine, reject, propose

reflect
write

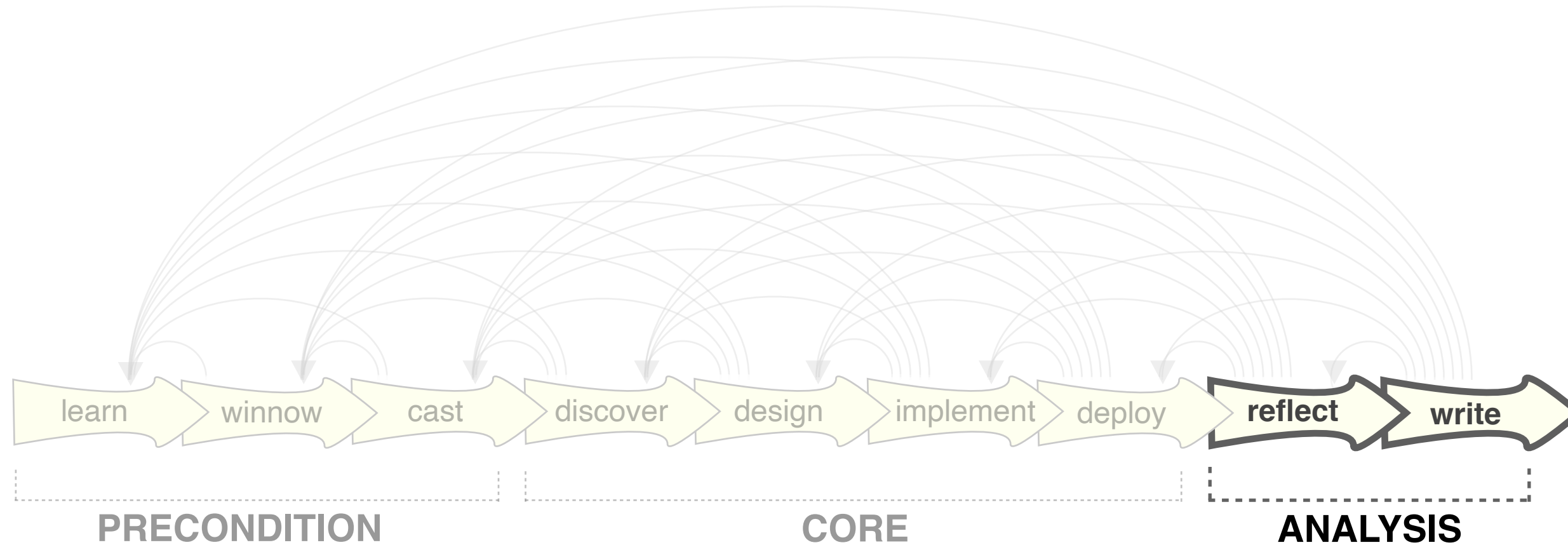

9-stage framework

iterative

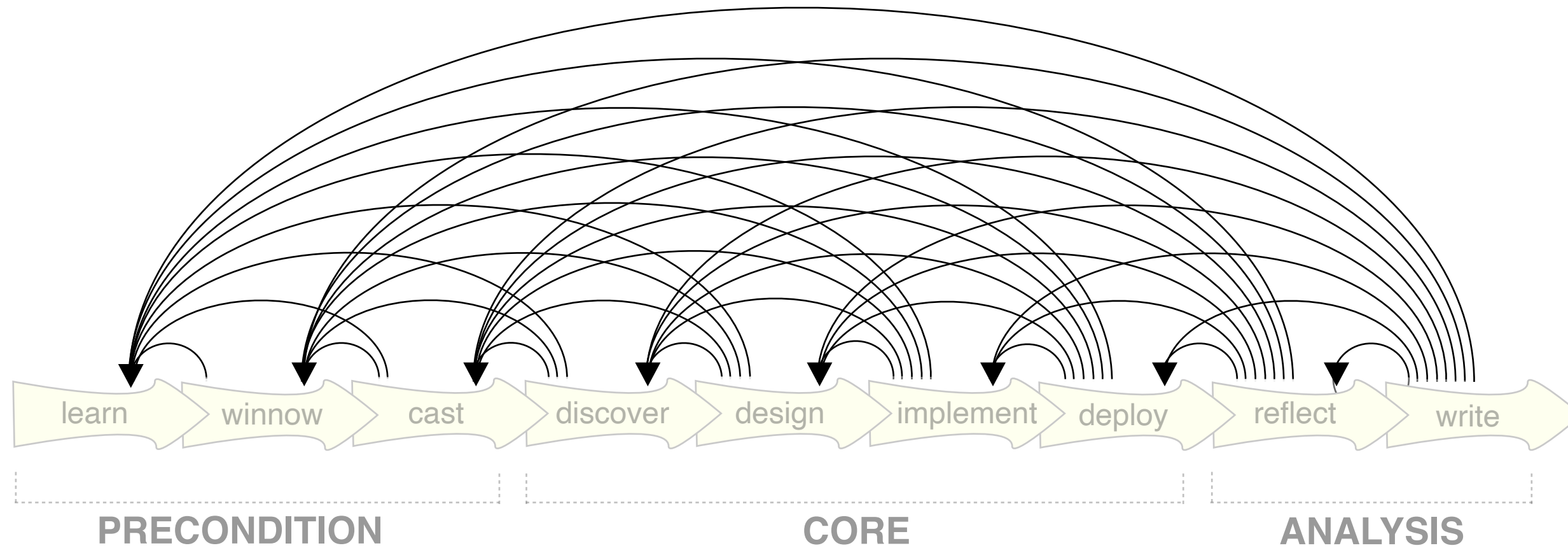

32 pitfalls & how to avoid them

32 pitfalls & how to avoid them



PF-1	premature advance: jumping forward over stages	general
PF-2	premature start: insufficient knowledge of vis literature	learn
PF-3	premature commitment: collaboration with wrong people	winnow
PF-4	no real data available (yet)	winnow
PF-5	insufficient time available from potential collaborators	winnow
PF-6	no need for visualization: problem can be automated	winnow
PF-7	researcher expertise does not match domain problem	winnow
PF-8	no need for research: engineering vs. research project	winnow
PF-9	no need for change: existing tools are good enough	winnow
PF-10	no real/important/recurring task	winnow
PF-11	no rapport with collaborators	winnow
PF-12	not identifying front line analyst and gatekeeper before start	cast
PF-13	assuming every project will have the same role distribution	cast
PF-14	mistaking fellow tool builders for real end users	cast

32 pitfalls & how to avoid them



PF-1	premature advance: jumping forward over stages	general	PF-21	mistaking technique-driven for problem-driven work	design
PF-2	premature start: insufficient knowledge of vis literature	learn	PF-22	nonrapid prototyping	implement
PF-3	premature commitment: collaboration with wrong people	winnow	PF-23	usability: too little / too much	implement
PF-4	no real data available (yet)	winnow	PF-24	premature end: insufficient deploy time built into schedule	deploy
PF-5	insufficient time available from potential collaborators	winnow	PF-25	usage study not case study: non-real task/data/user	deploy
PF-6	no need for visualization: problem can be automated	winnow	PF-26	<i>liking</i> necessary but not sufficient for validation	deploy
PF-7	researcher expertise does not match domain problem	winnow			
PF-8	no need for research: engineering vs. research project	winnow			
PF-9	no need for change: existing tools are good enough	winnow			
PF-10	no real/important/recurring task	winnow			
PF-11	no rapport with collaborators	winnow			
PF-12	not identifying front line analyst and gatekeeper before start	cast			
PF-13	assuming every project will have the same role distribution	cast			
PF-14	mistaking fellow tool builders for real end users	cast			
PF-15	ignoring practices that currently work well	discover			
PF-16	expecting <i>just talking or fly on wall</i> to work	discover			
PF-17	experts focusing on visualization design vs. domain problem	discover			
PF-18	learning their problems/language: too little / too much	discover			
PF-19	abstraction: too little	design			
PF-20	premature design commitment: consideration space too small	design			

32 pitfalls & how to avoid them



PF-1	premature advance: jumping forward over stages	general	PF-21	mistaking technique-driven for problem-driven work	design
PF-2	premature start: insufficient knowledge of vis literature	learn	PF-22	nonrapid prototyping	implement
PF-3	premature commitment: collaboration with wrong people	winnow	PF-23	usability: too little / too much	implement
PF-4	no real data available (yet)	winnow	PF-24	premature end: insufficient deploy time built into schedule	deploy
PF-5	insufficient time available from potential collaborators	winnow	PF-25	usage study not case study: non-real task/data/user	deploy
PF-6	no need for visualization: problem can be automated	winnow	PF-26	<i>liking</i> necessary but not sufficient for validation	deploy
PF-7	researcher expertise does not match domain problem	winnow	PF-27	failing to improve guidelines: confirm, refine, reject, propose	reflect
PF-8	no need for research: engineering vs. research project	winnow	PF-28	insufficient writing time built into schedule	write
PF-9	no need for change: existing tools are good enough	winnow	PF-29	no technique contribution \neq good design study	write
PF-10	no real/important/recurring task	winnow	PF-30	too much domain background in paper	write
PF-11	no rapport with collaborators	winnow	PF-31	story told chronologically vs. focus on final results	write
PF-12	not identifying front line analyst and gatekeeper before start	cast	PF-32	premature end: win race vs. practice music for debut	write
PF-13	assuming every project will have the same role distribution	cast			
PF-14	mistaking fellow tool builders for real end users	cast			
PF-15	ignoring practices that currently work well	discover			
PF-16	expecting <i>just talking or fly on wall</i> to work	discover			
PF-17	experts focusing on visualization design vs. domain problem	discover			
PF-18	learning their problems/language: too little / too much	discover			
PF-19	abstraction: too little	design			
PF-20	premature design commitment: consideration space too small	design			

Design studies & user-centered design

- user-centered design: well-known HCI methodology
 - iterative refinement & deployment
 - evaluation through case studies & field studies

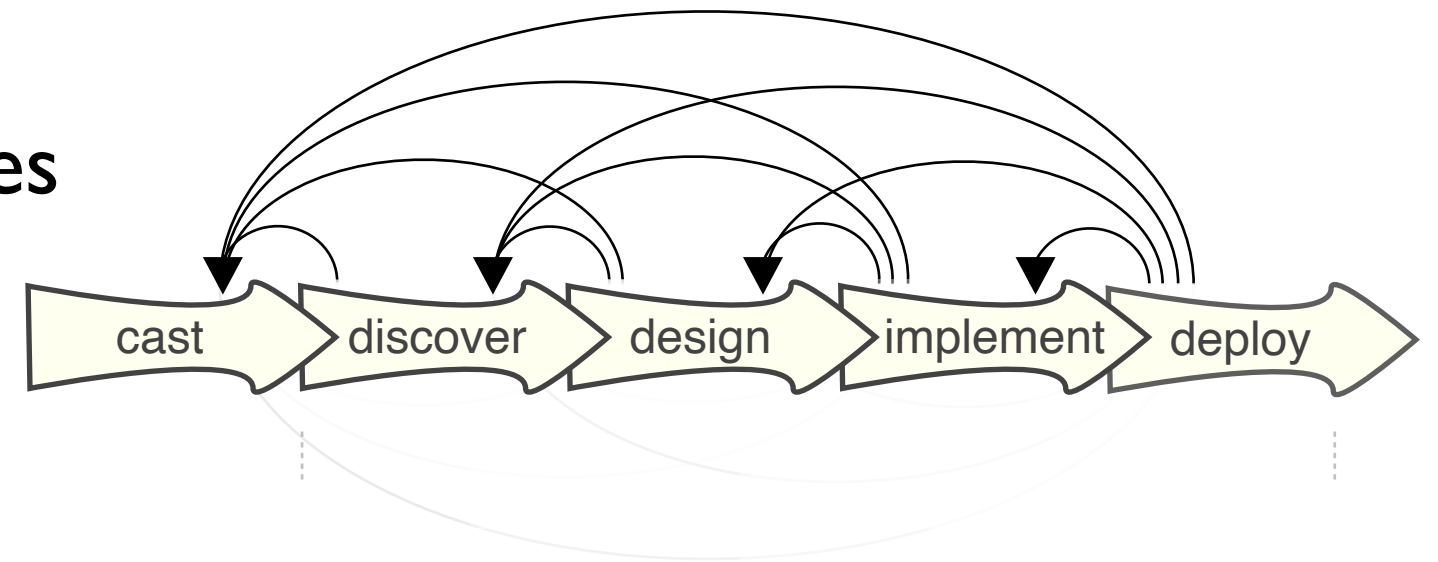

Design studies & user-centered design

- user-centered design: well-known HCI methodology
 - iterative refinement & deployment
 - evaluation through case studies & field studies

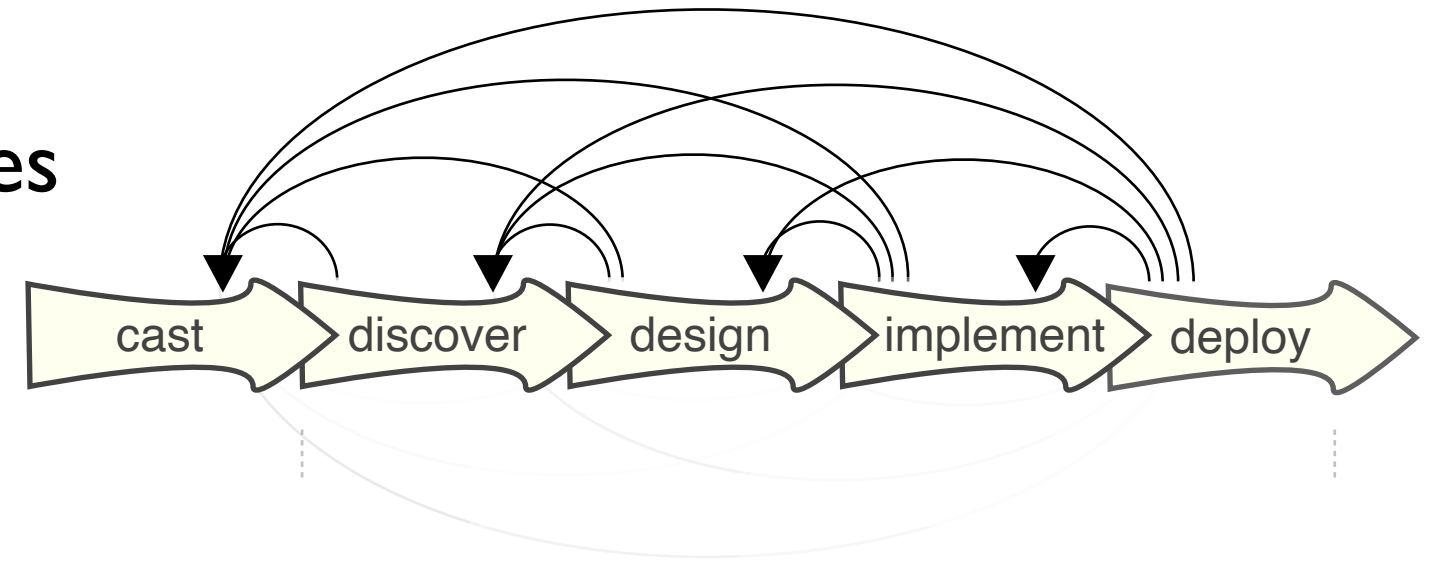

- what's specific to visualization?
 - discovering task and data **abstractions**
 - designing visual encoding & interaction **idioms** that map to abstractions

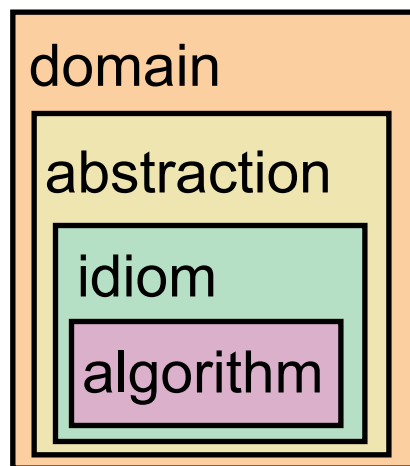

Three case studies of problem-driven work

- e-commerce



- facilities management



- biology



Three case studies of problem-driven work

- e-commerce



- facilities management



- biology





Kim
Dextras-Romagnino



Segmentifier

Interactive Refinement of Clickstream Data

<http://www.cs.ubc.ca/labs/imager/tr/2019/segmentifier>

Segmentifier: Interactive Refinement of Clickstream Data.

Dextras-Romagnino and Munzner. *Computer Graphics Forum (Proc. EuroVis 2019)* 38(3):623–634 2019

E-commerce: mobile apps for large companies



Process: Design Study Methodology

- **Precondition Phase** (5 months) : interviews with 12 employees
- **Core Phase** (11 months): Iterative design and implementation
- **Analysis Phase** (3 months): Reflect and write

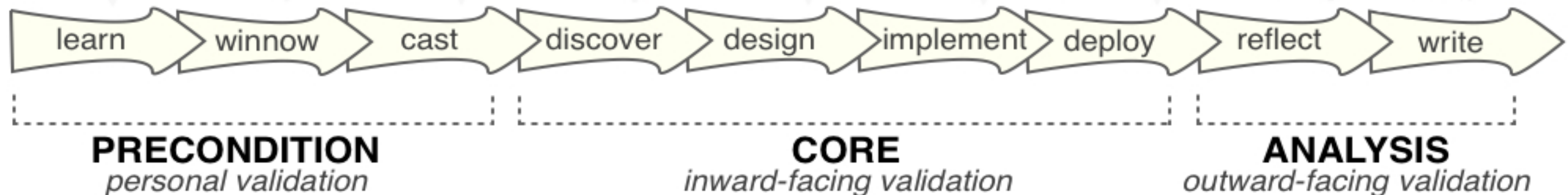

What are the **Data and Task Abstractions** for *Clickstream Data Analysis*?

Clickstream Data

Clickstream Analysis Tasks

Segmentifier Analysis Model

What is ***Clickstream Data***?

Data: *Actions*

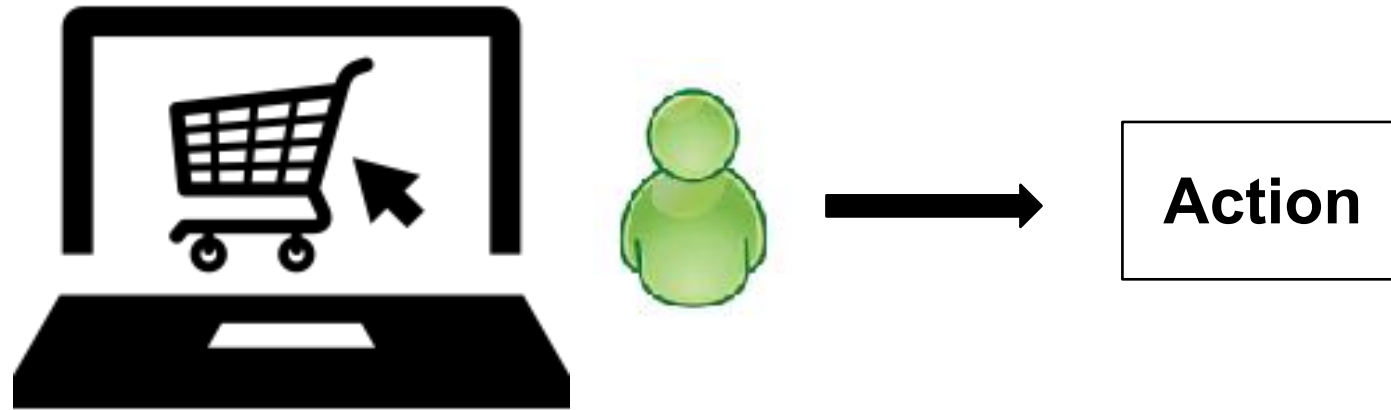

Data: *Action Attributes*

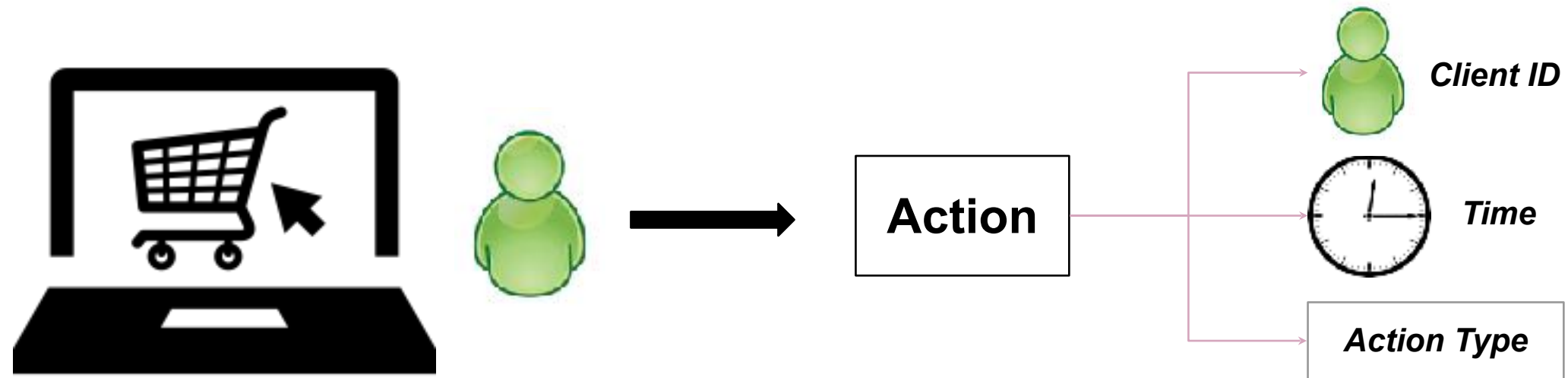

Data: *Action Types*

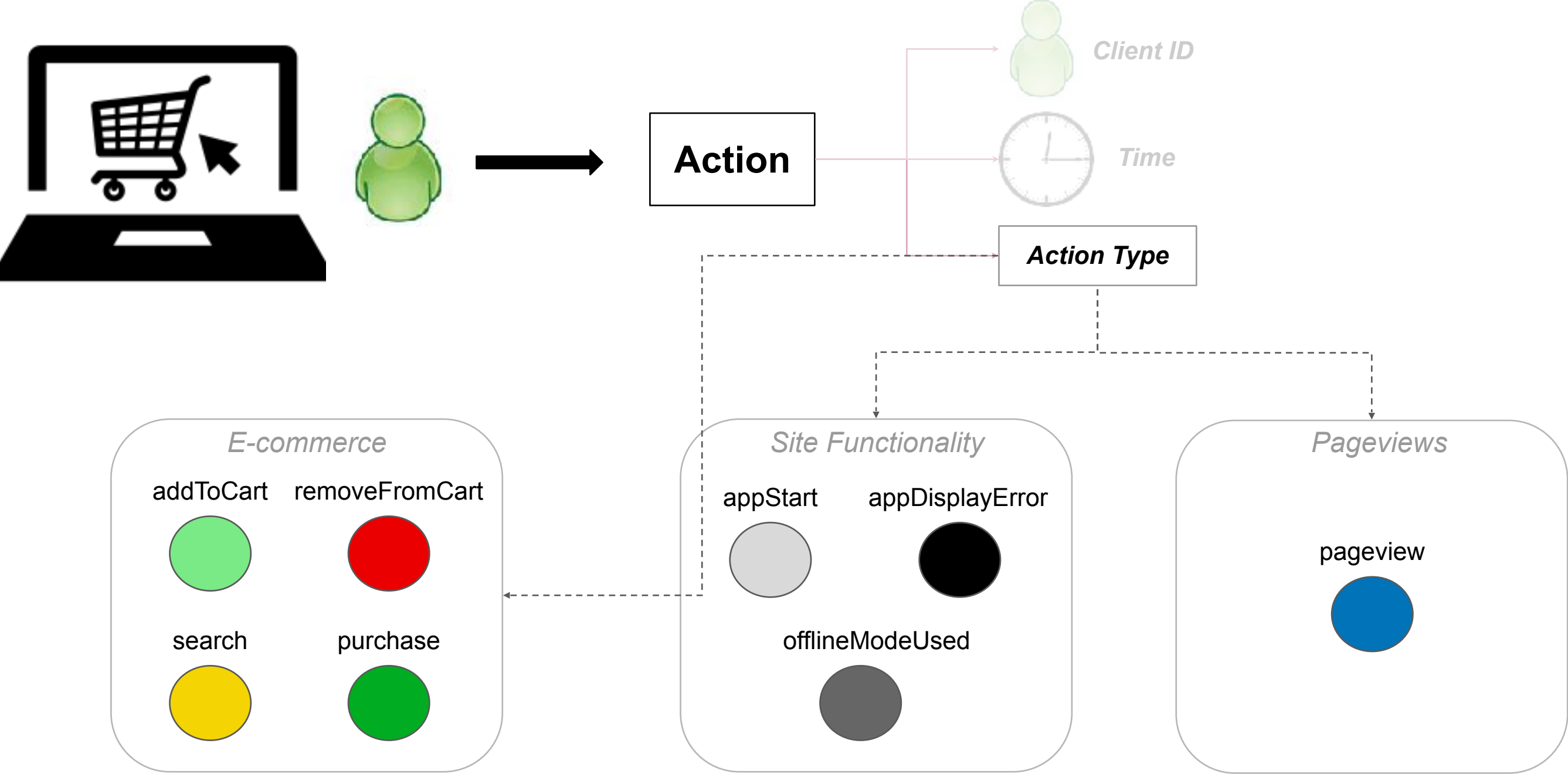

Action Hierarchy



Action Hierarchy

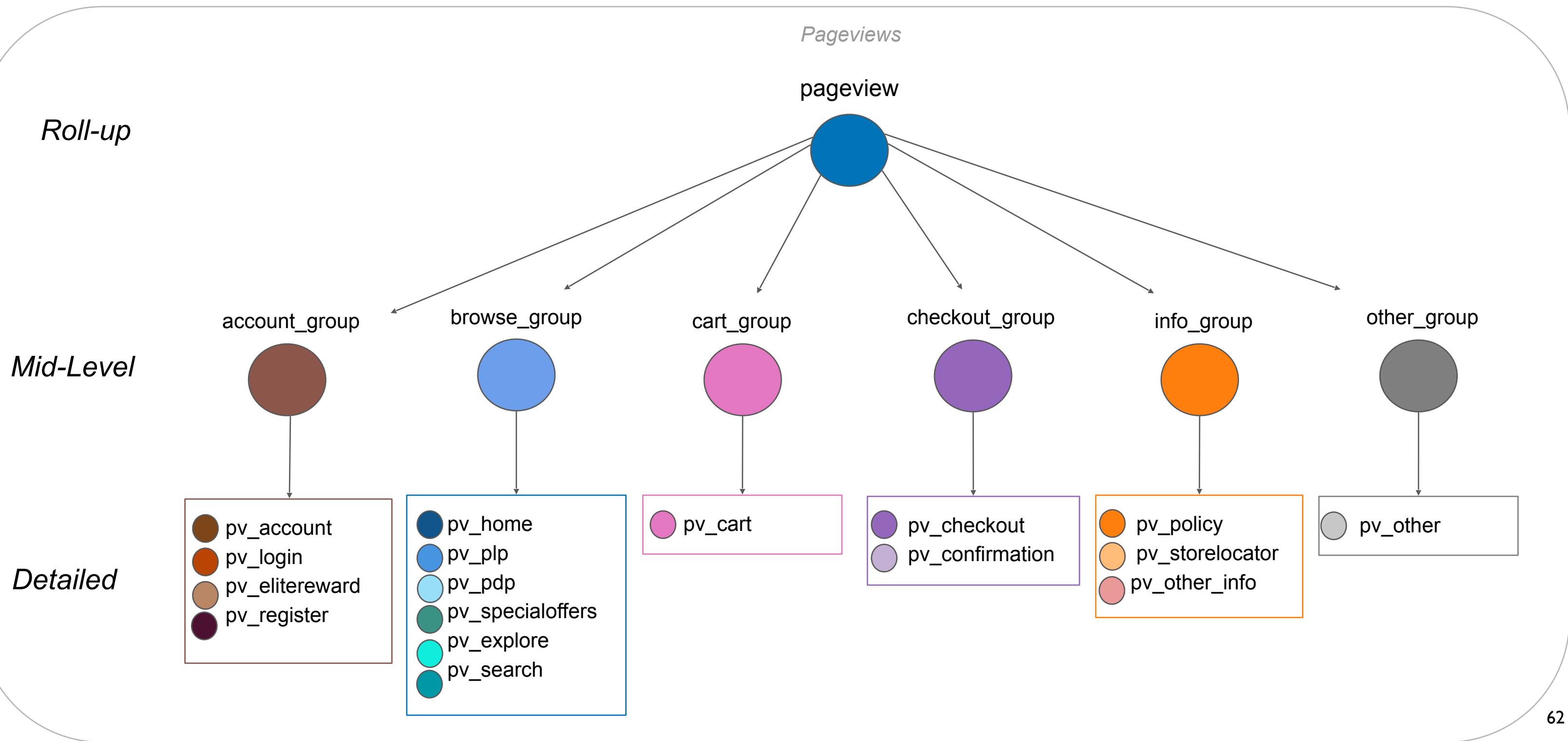

Data: *Sequences*

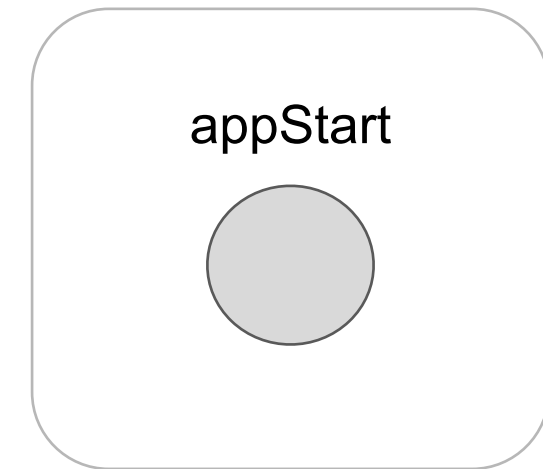
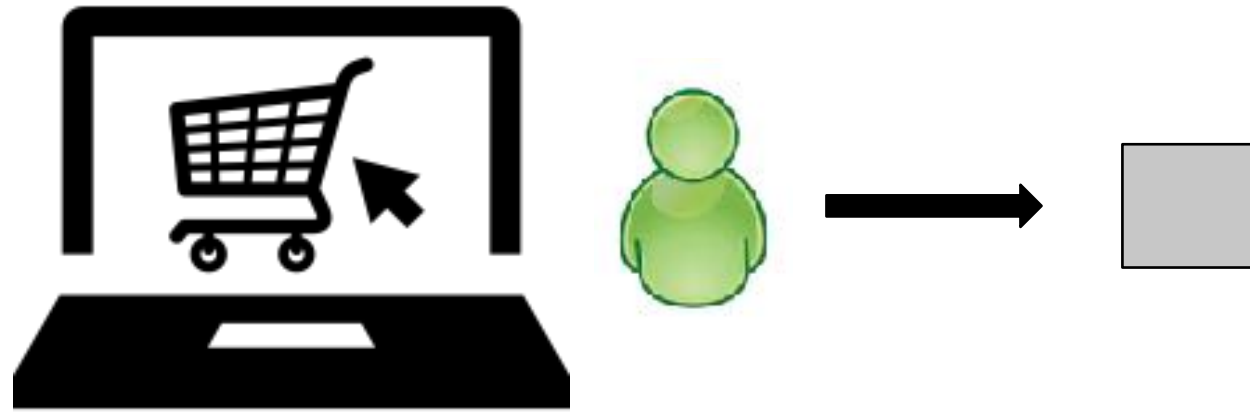

Data: *Sequences*

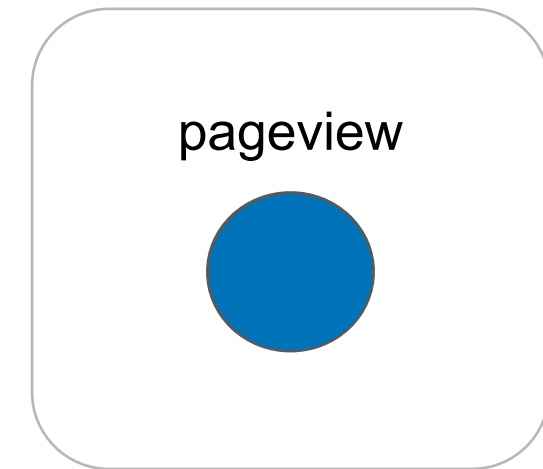
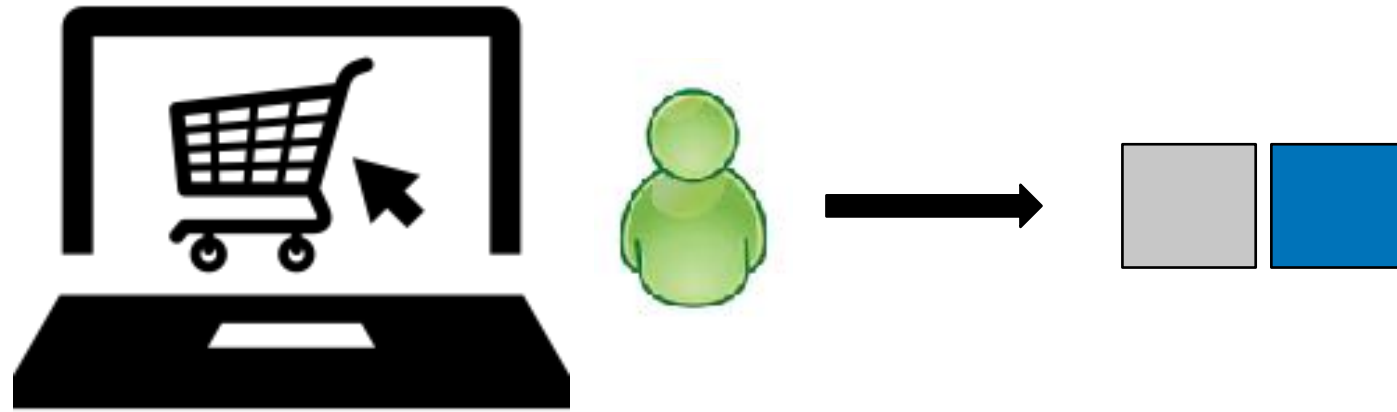

Data: *Client Sequences*

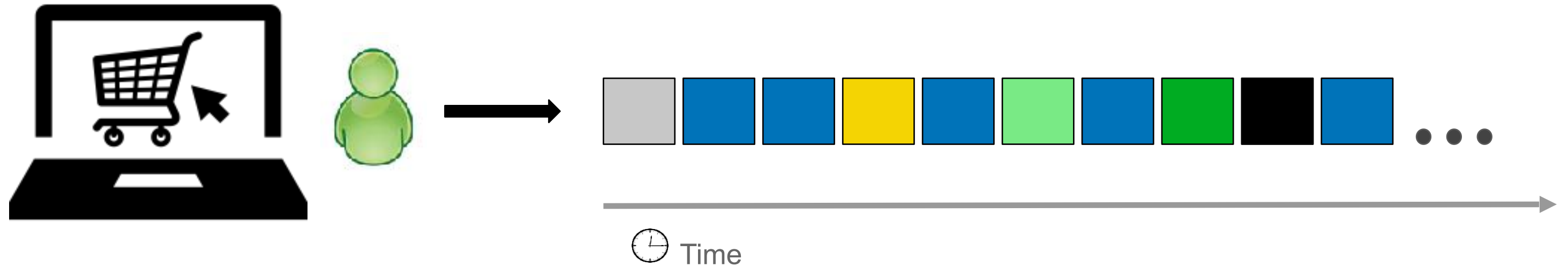

Client Sequences: all actions performed by a single user

Data: *Session Sequences*



Session Sequences: all actions performed by a single user within a defined amount of time (Δ) from each other.
 Δ is usually 30 min.

Data: *Sequence Attributes*

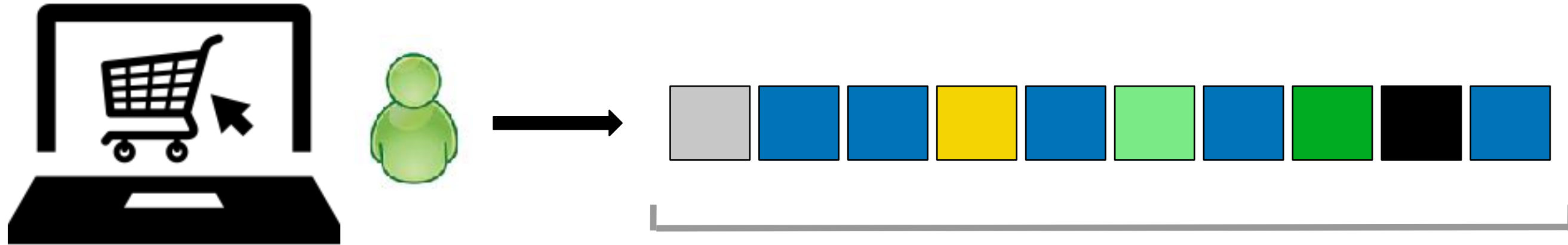

Start time

End time

Duration

Action Counts

■ : 1
■ : 1
■ : 5
■ : 1
■ : 1

Data: *Segments*

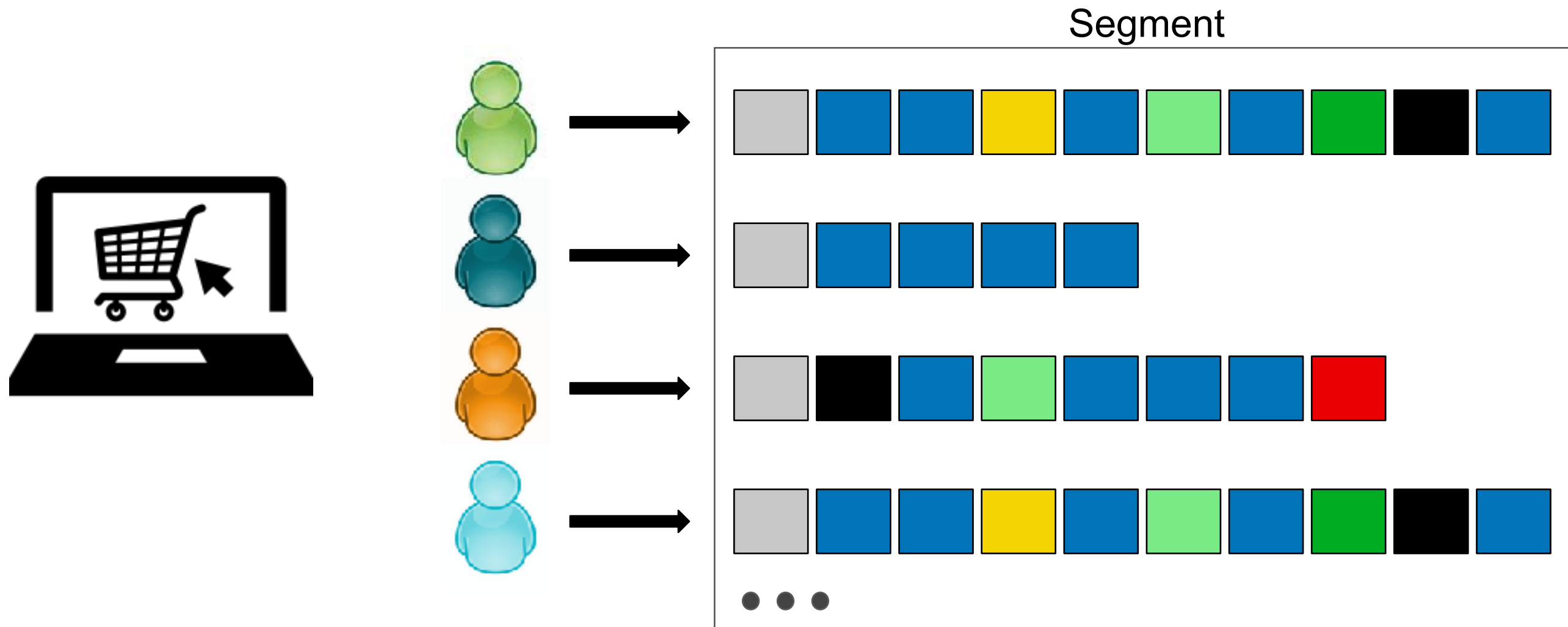

Segment: any set of sequences

Data: *Segment Attributes*

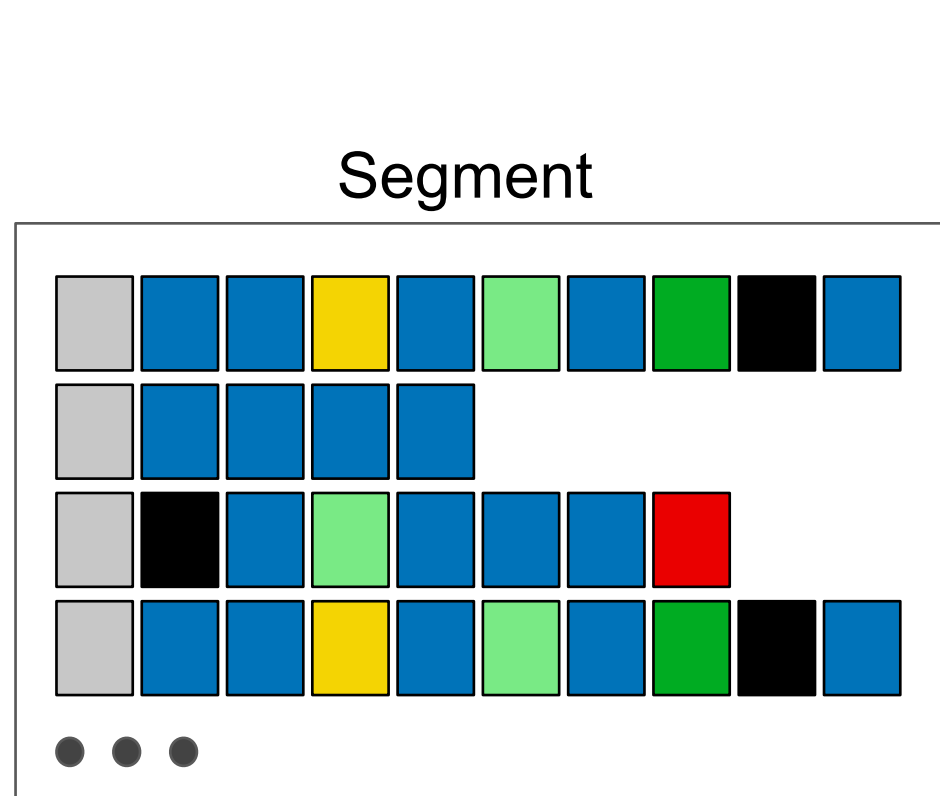

Size

Counts of sequences:
Absolute, Relative

Sequence Related

Sequence Distributions:
Start Time, Duration, Action Counts



Action Related

Action Distributions:
Action Transitions:
action before, action after

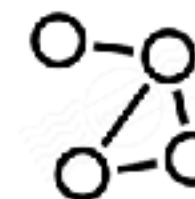

Real-world Clickstream Data

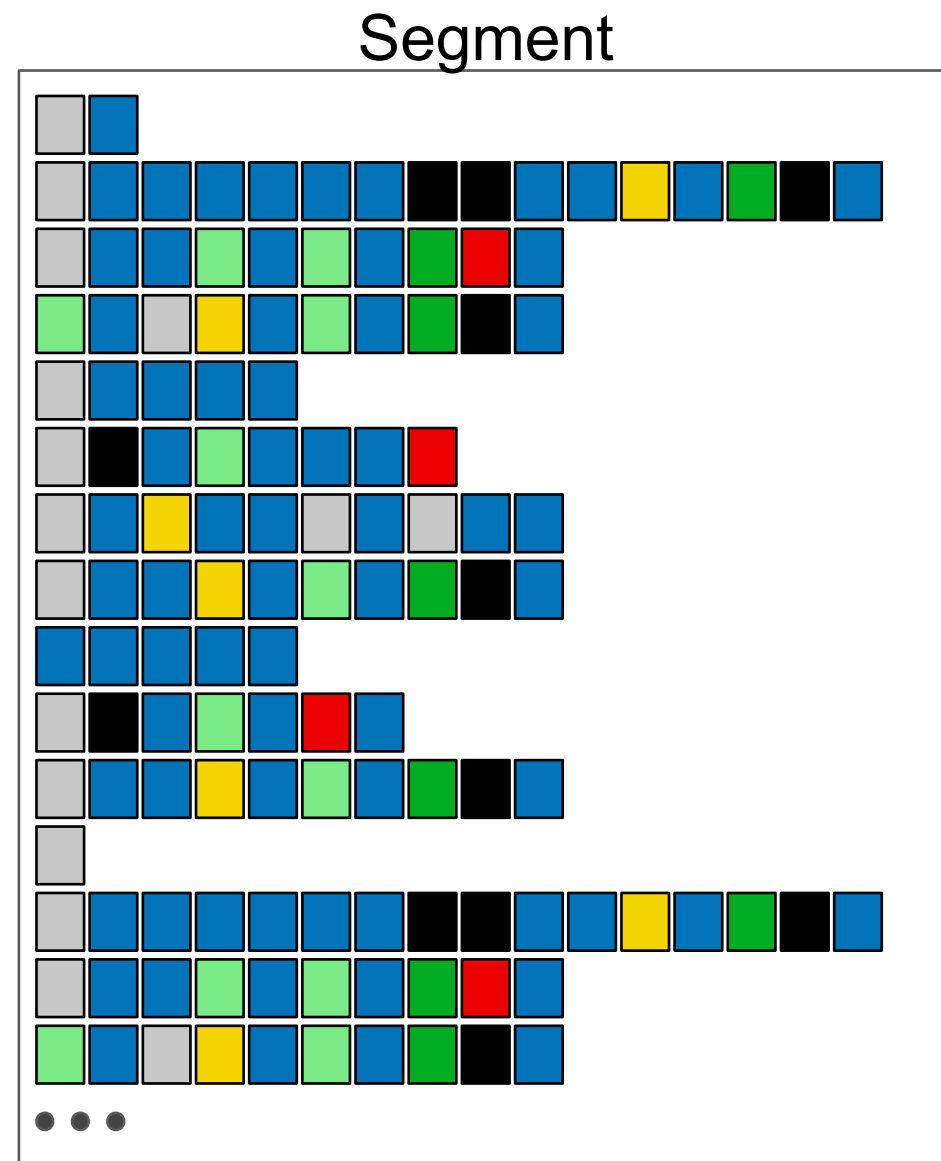

Real-world Clickstream Data

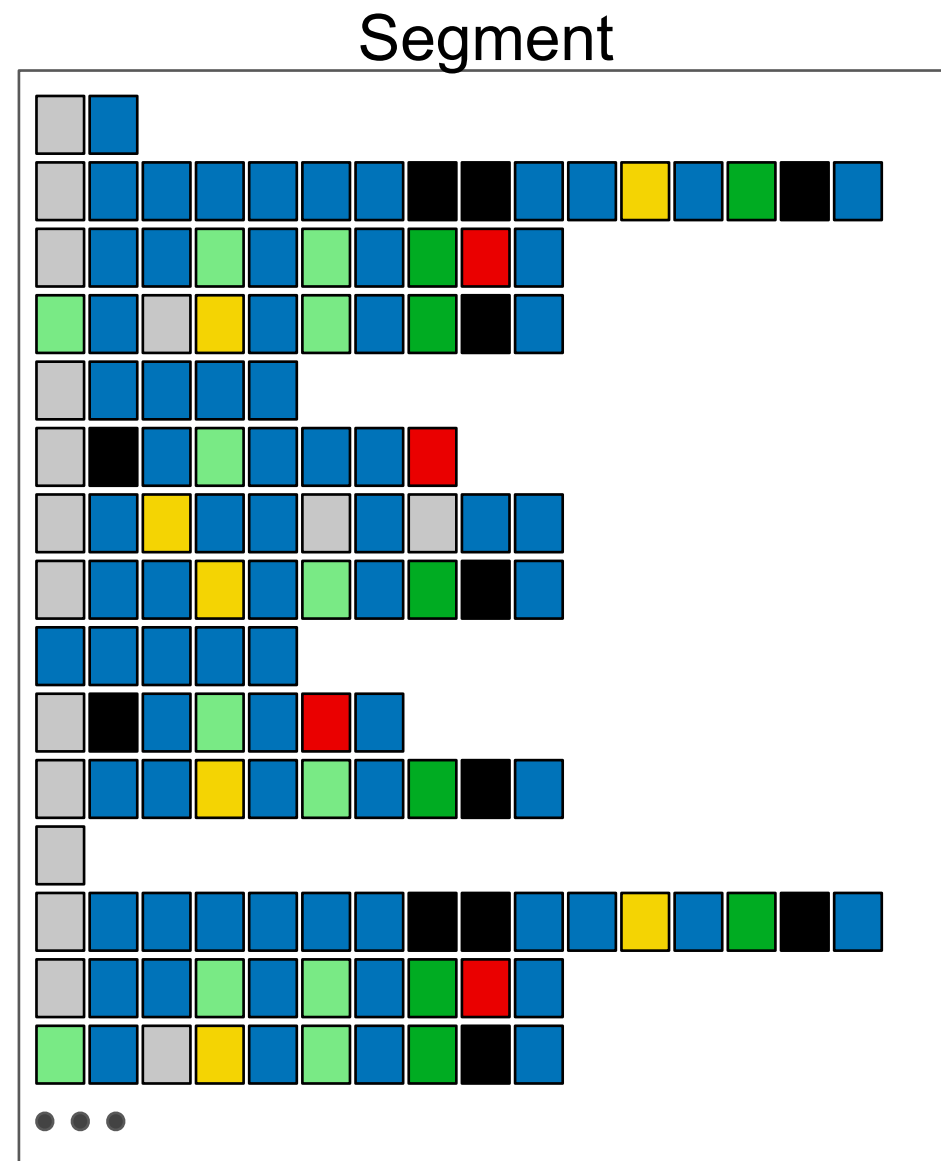

Scale is huge



Real-world Clickstream Data

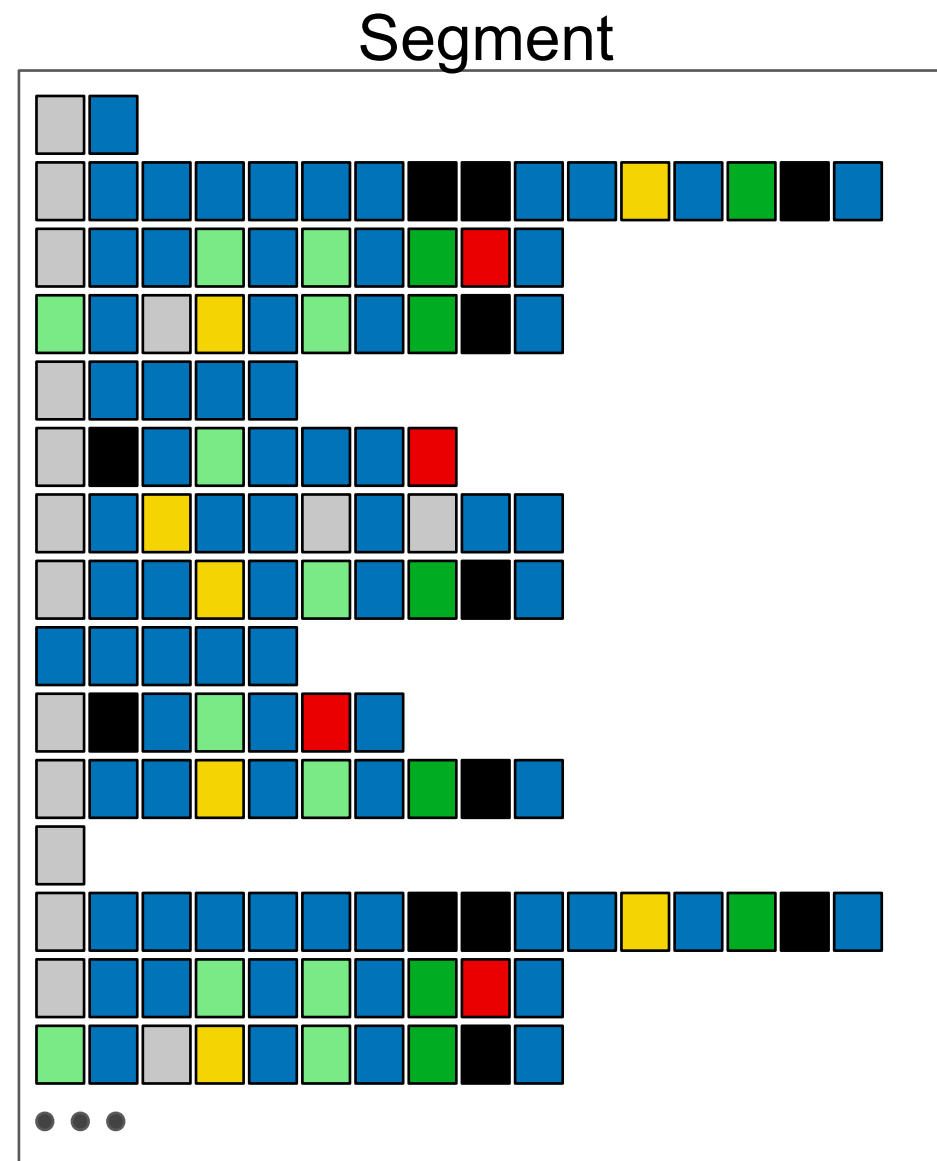

Scale is huge

Variability is high

Real-world Clickstream Data

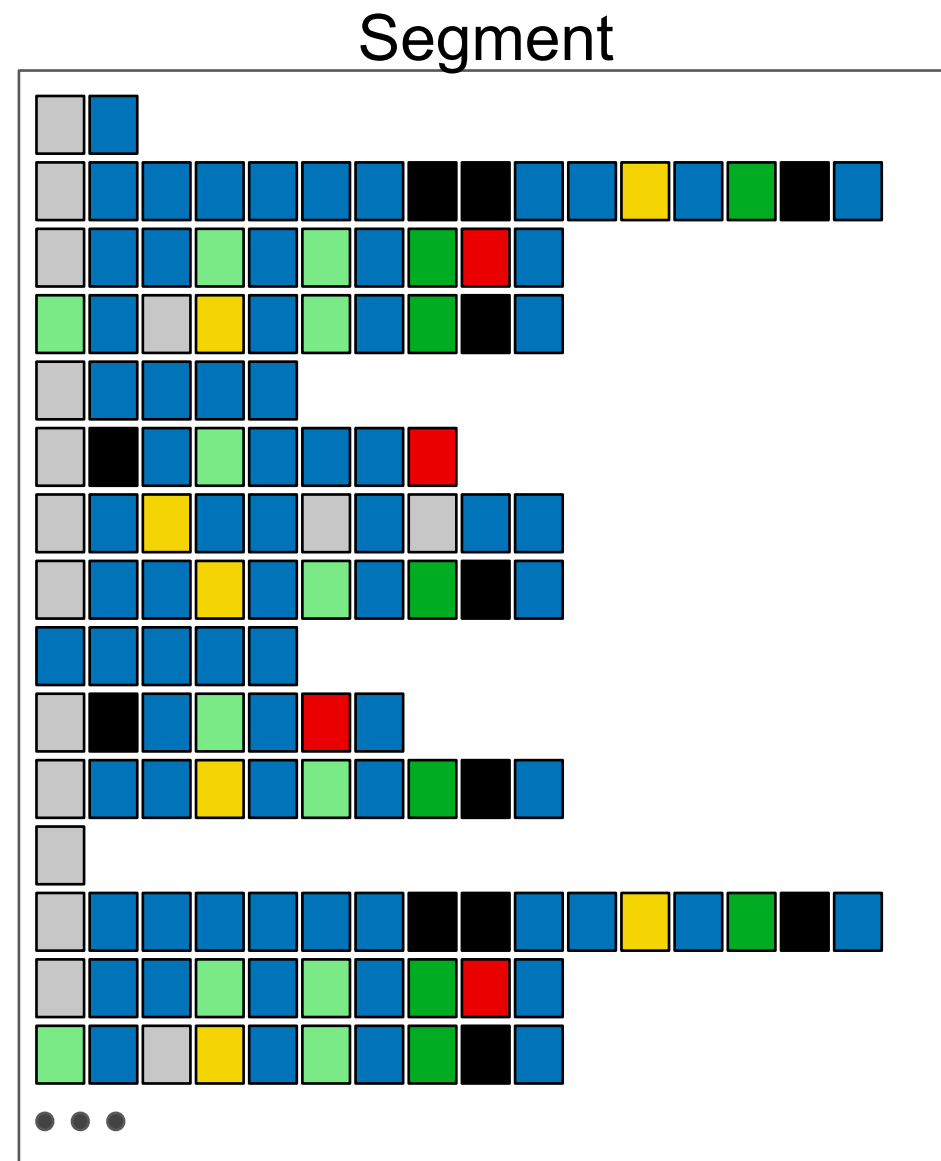

Scale is huge

Variability is high

Most work **fails** when
applied to real-world data

What are
Clickstream Data Analysis Tasks?

Tasks: Segment Behavior

Segment

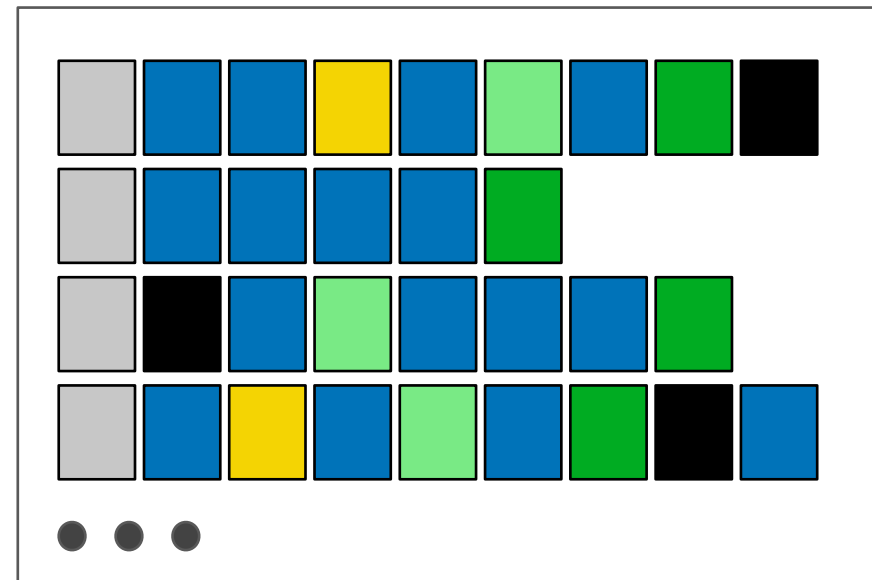

Behavior

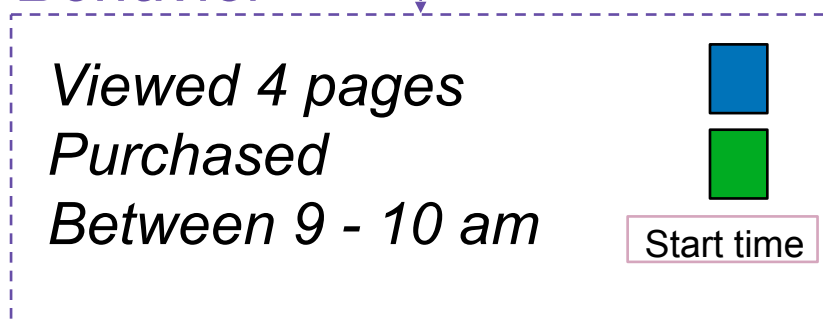

Behavior: set of attribute constraints

Tasks: Segment Behavior

Segment

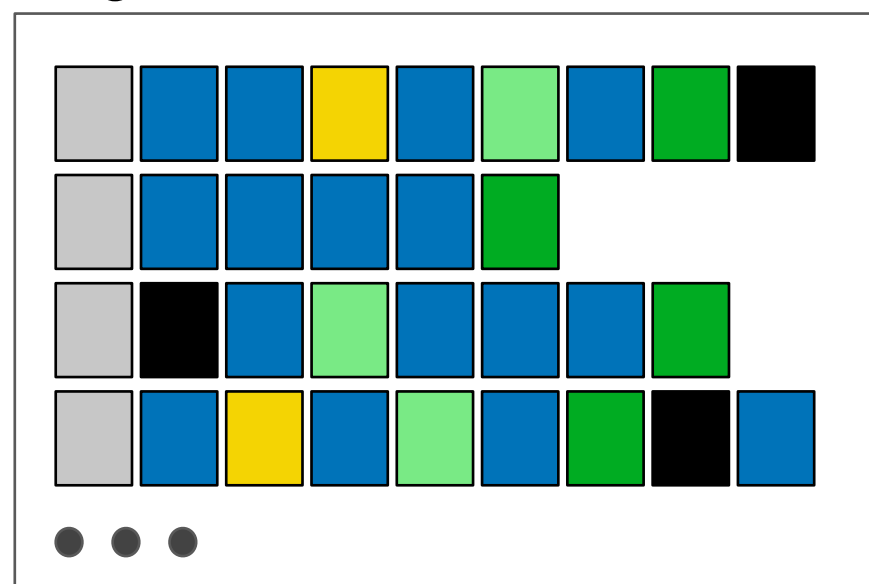

Behavior

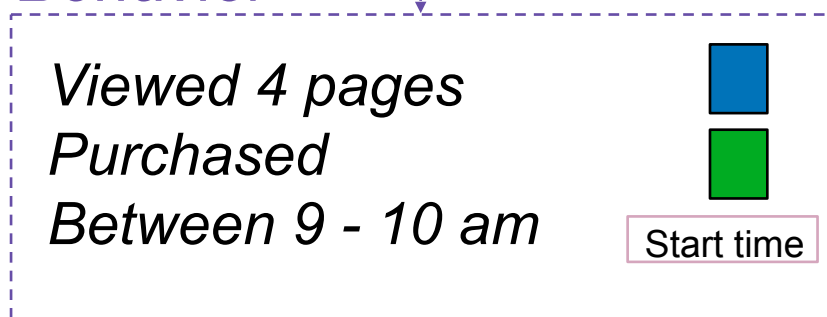

Behavior: set of attribute constraints

- **Expected**
Users add to cart before purchasing
- **Unexpected**
No purchases on a certain month
- **Favorable**
Purchased
- **Unfavorable**
Bounced

Tasks: Task Abstraction

Segment

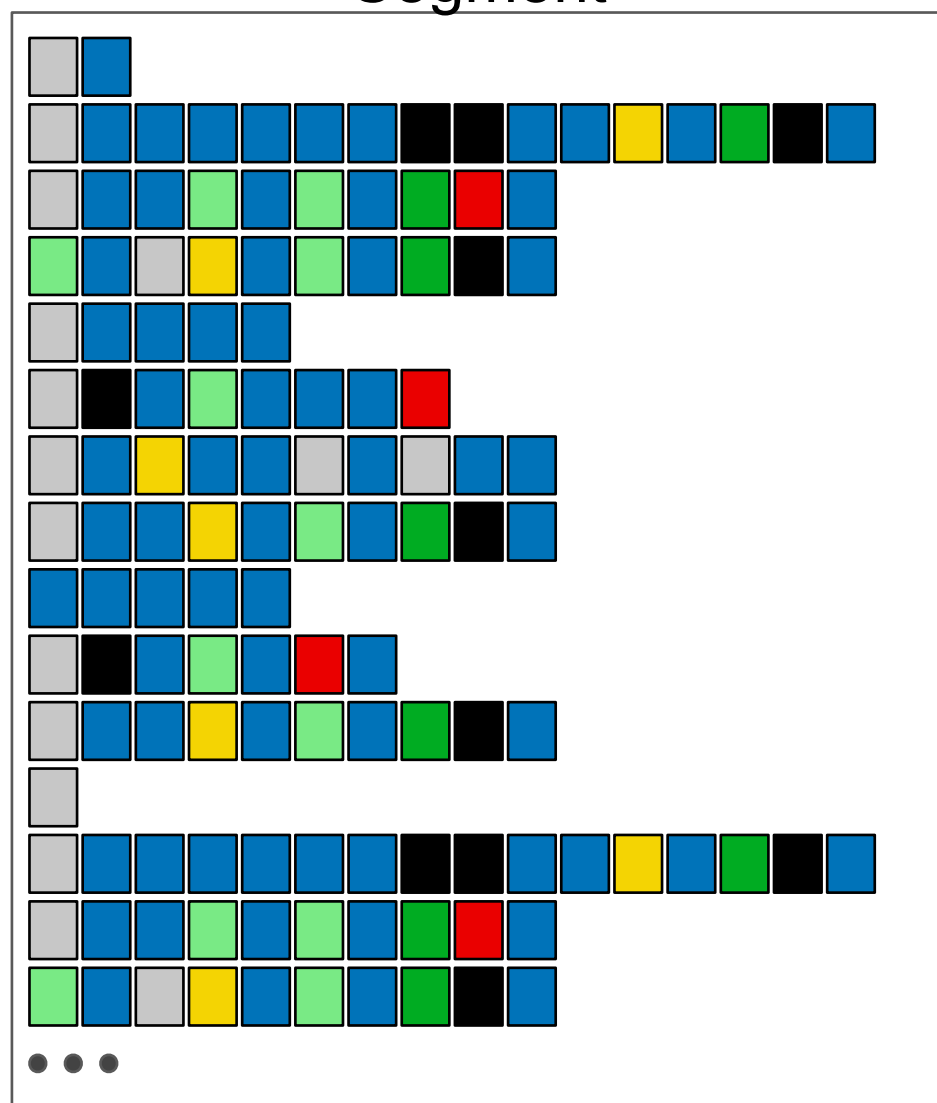

Identify: Find some set of sequences that constitutes interesting *behavior*

Tasks: Task Abstraction

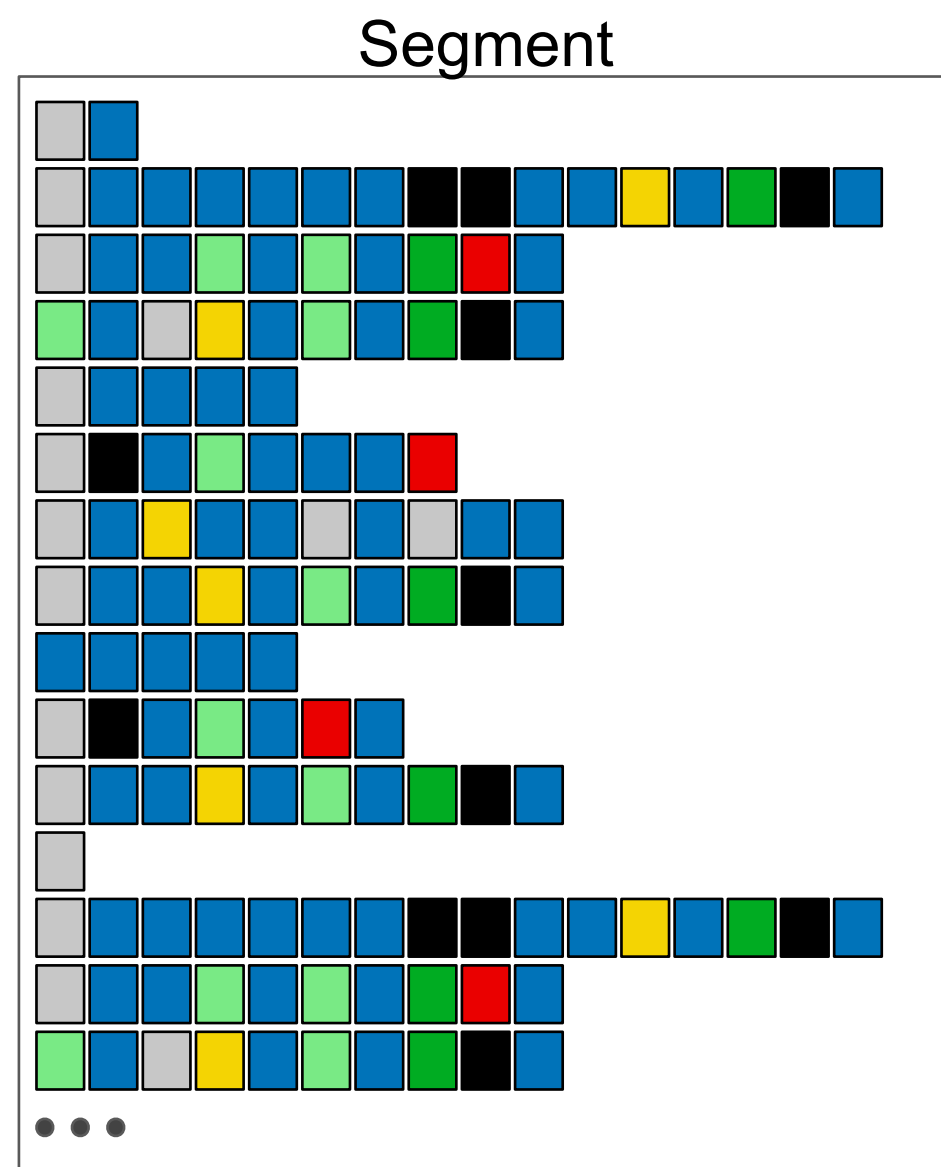

Identify: Find some set of sequences that constitutes interesting *behavior*

Drilldown: Distinguish more specific *behaviors* to further partition a segment previously defined by looser constraints

Tasks: Task Abstraction

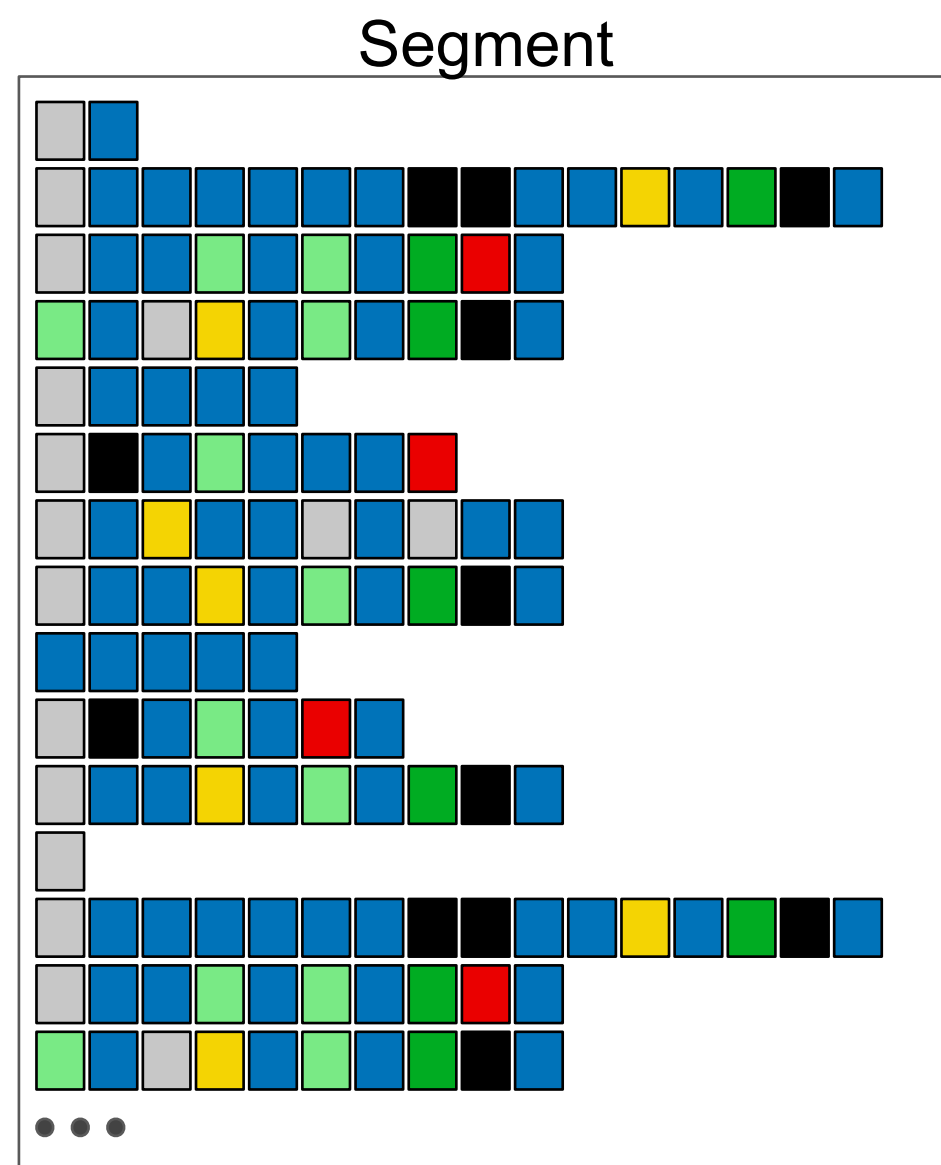

Identify: Find some set of sequences that constitutes interesting *behavior*

Drilldown: Distinguish more specific *behaviors* to further partition a segment previously defined by looser constraints

Frequency: Determine how many sequences are in the segment defined by *behavior*

Tasks: Task Abstraction

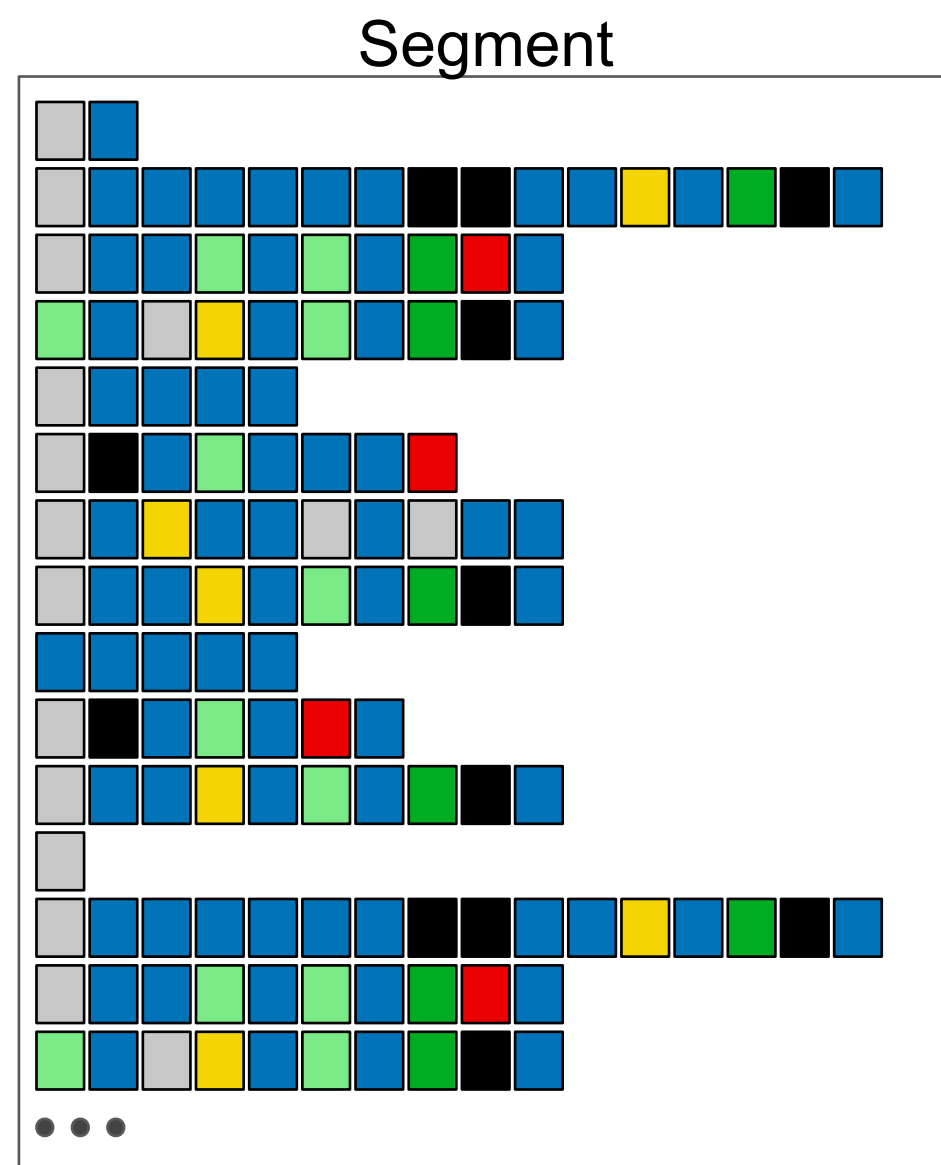

Identify: Find some set of sequences that constitutes interesting *behavior*

Drilldown: Distinguish more specific *behaviors* to further partition a segment previously defined by looser constraints

Frequency: Determine how many sequences are in the segment defined by *behavior*

Ordering within sequence: Match if one action subsequence occurs before (or after) another action subsequence in a sequence

High-Level Segmentifier Analysis Model

High-Level Segmentifier Analysis Model

- Abstraction above task/data level to provide design rationale
- Take a *giant, noisy dataset* and refine it into *small, clean segments* for
 - actionable insights
 - downstream analysis
- Bridge the gap between *real-world data* and other techniques

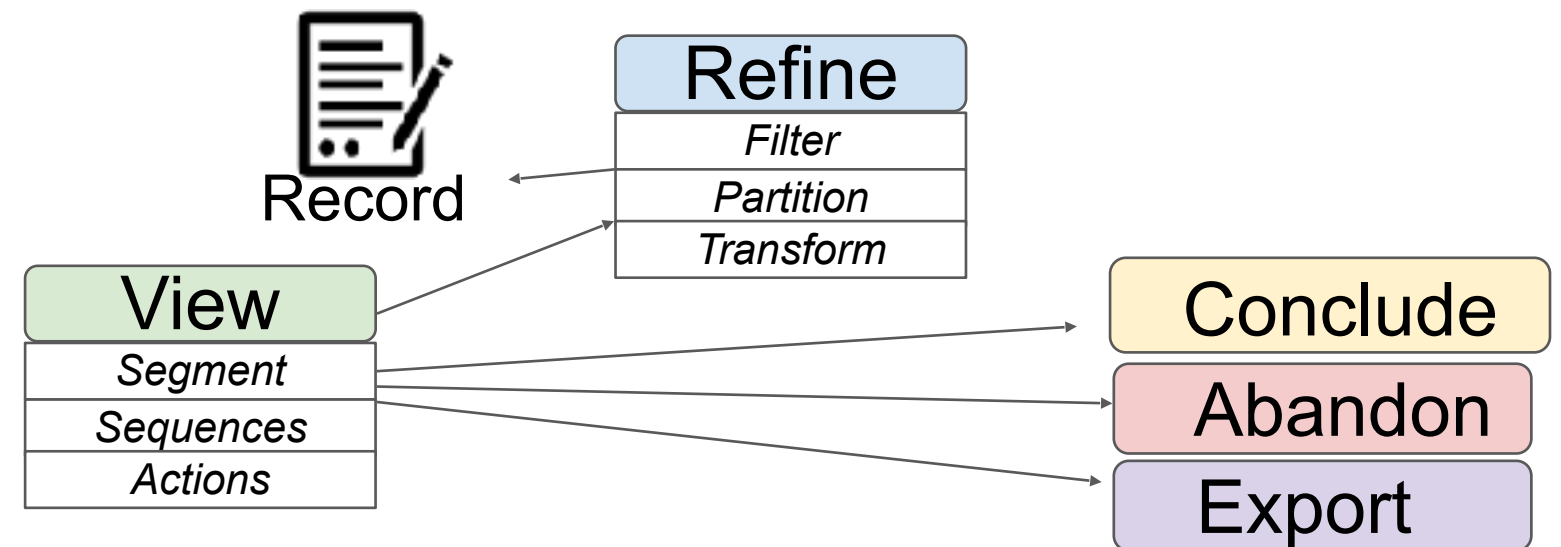

High-Level Segmentifier Analysis Model

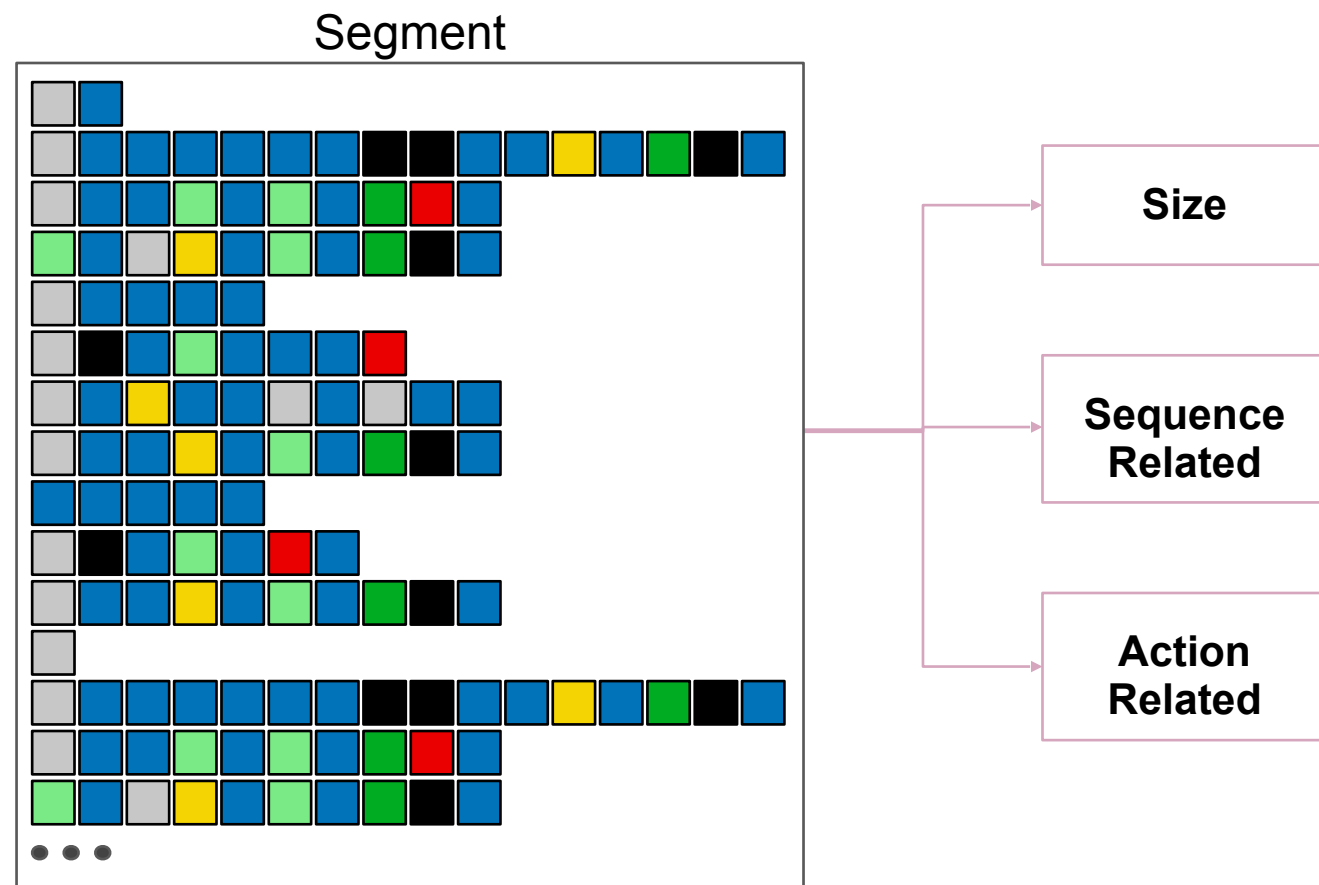
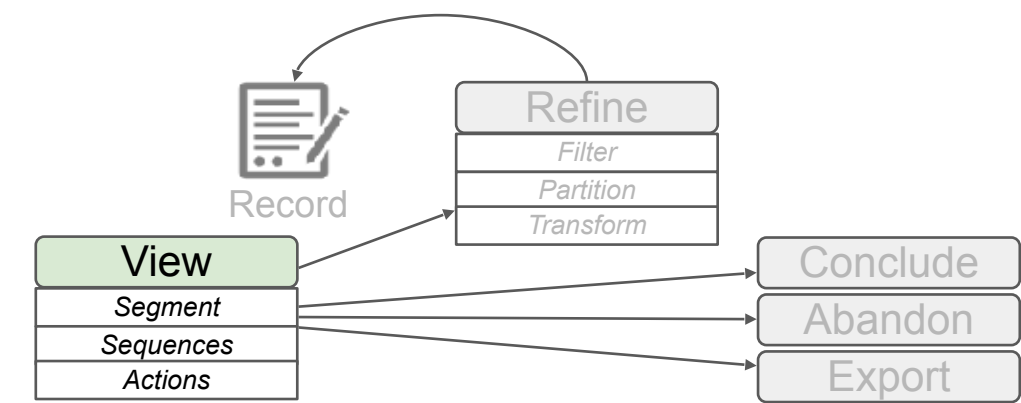

- Gives Insight into underlying data of segment
 - Action Attributes
 - Sequence Attributes
 - Segment Attributes
- Leads to:
 - Insights
 - New ways on how to *refine*
 - Whether segment should be *abandoned*
 - Whether segment should be *exported*

High-Level Segmentifier Analysis Model

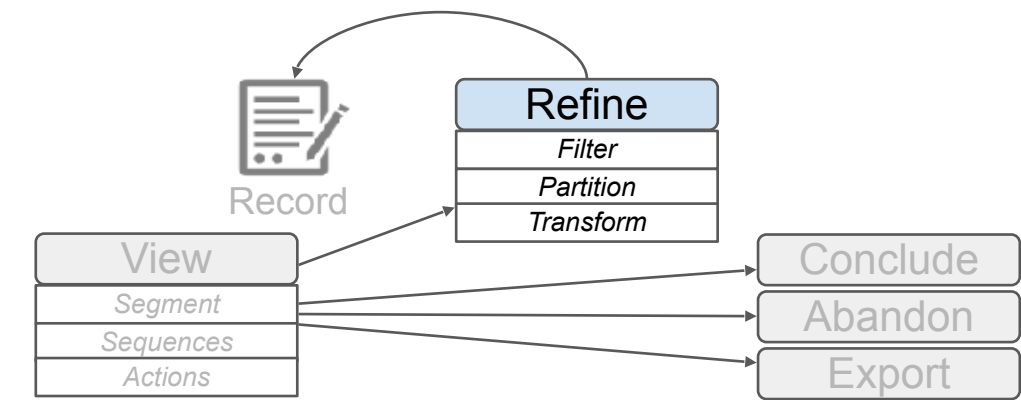
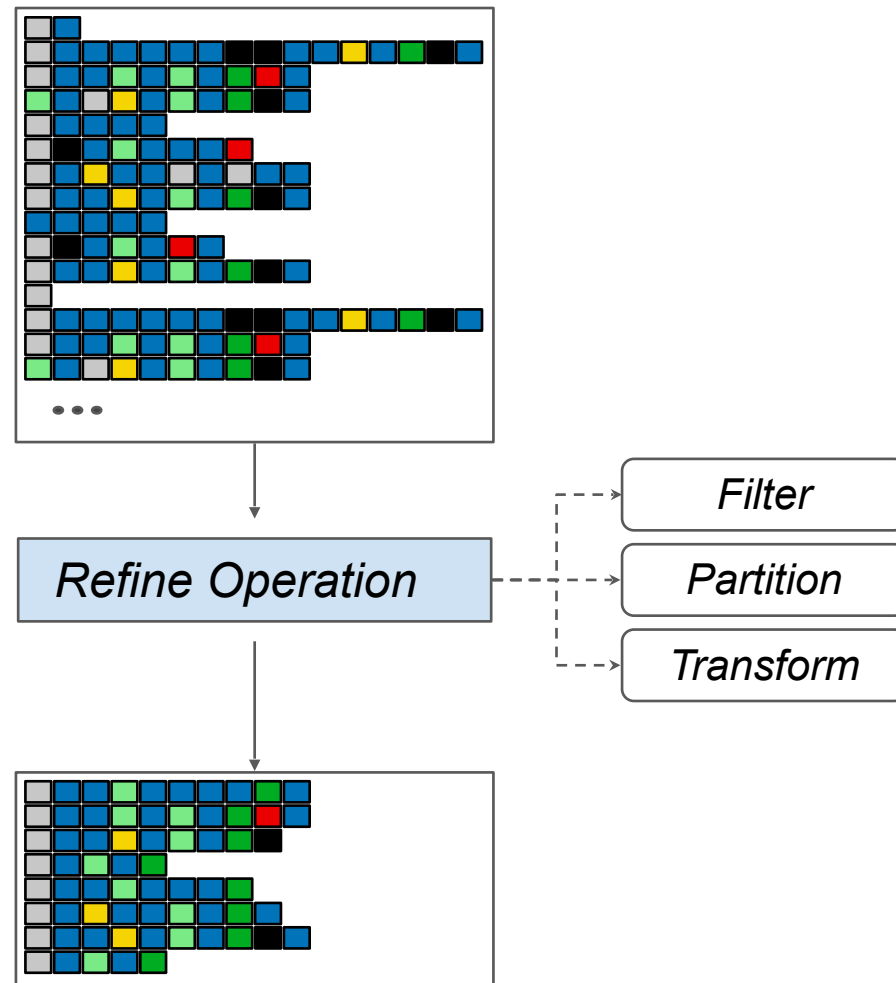

- Apply operation to create new segments
- Type of Refinements
 - *Filter*
 - *Partition*
 - *Transform*

High-Level Segmentifier Analysis Model

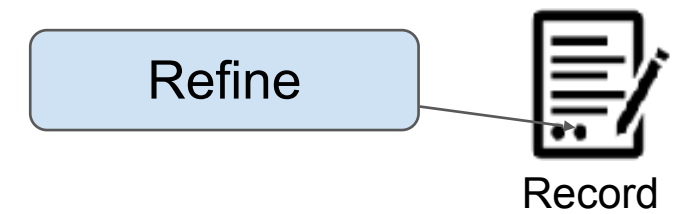
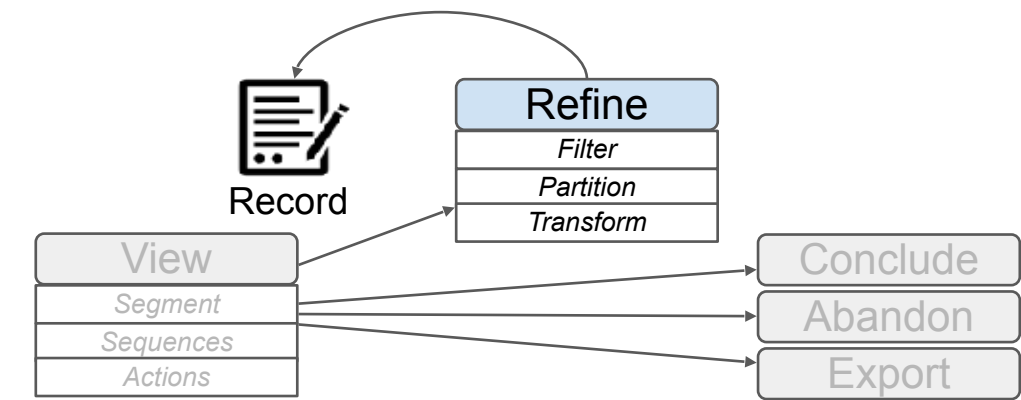
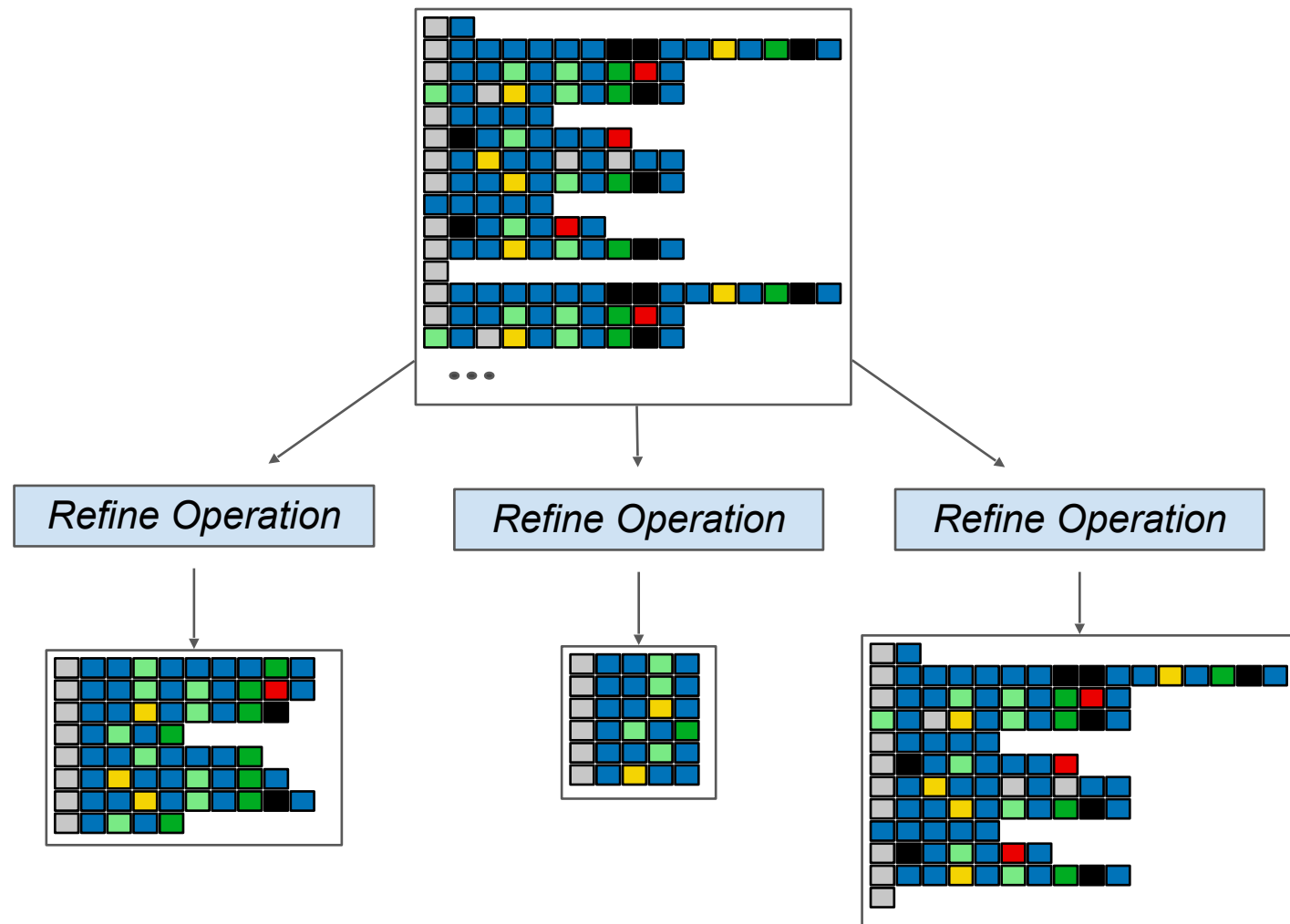

- Record all refinement steps automatically
- Keep track of questions asked and hypotheses tested
- Ability to create and view multiple segments from the same segment

High-Level Segmentifier Analysis Model

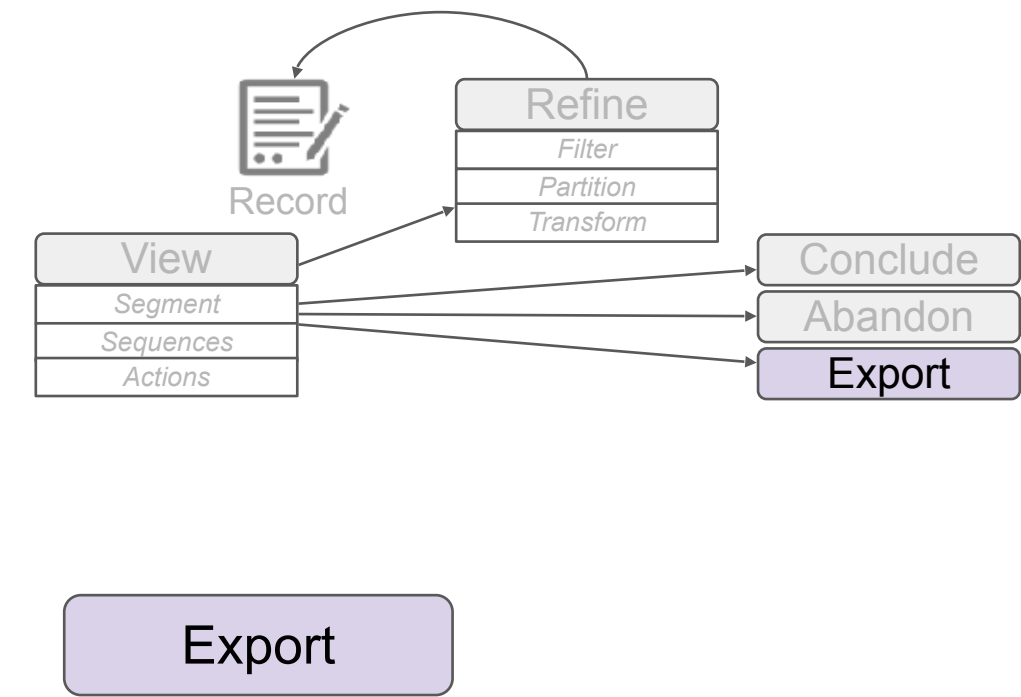
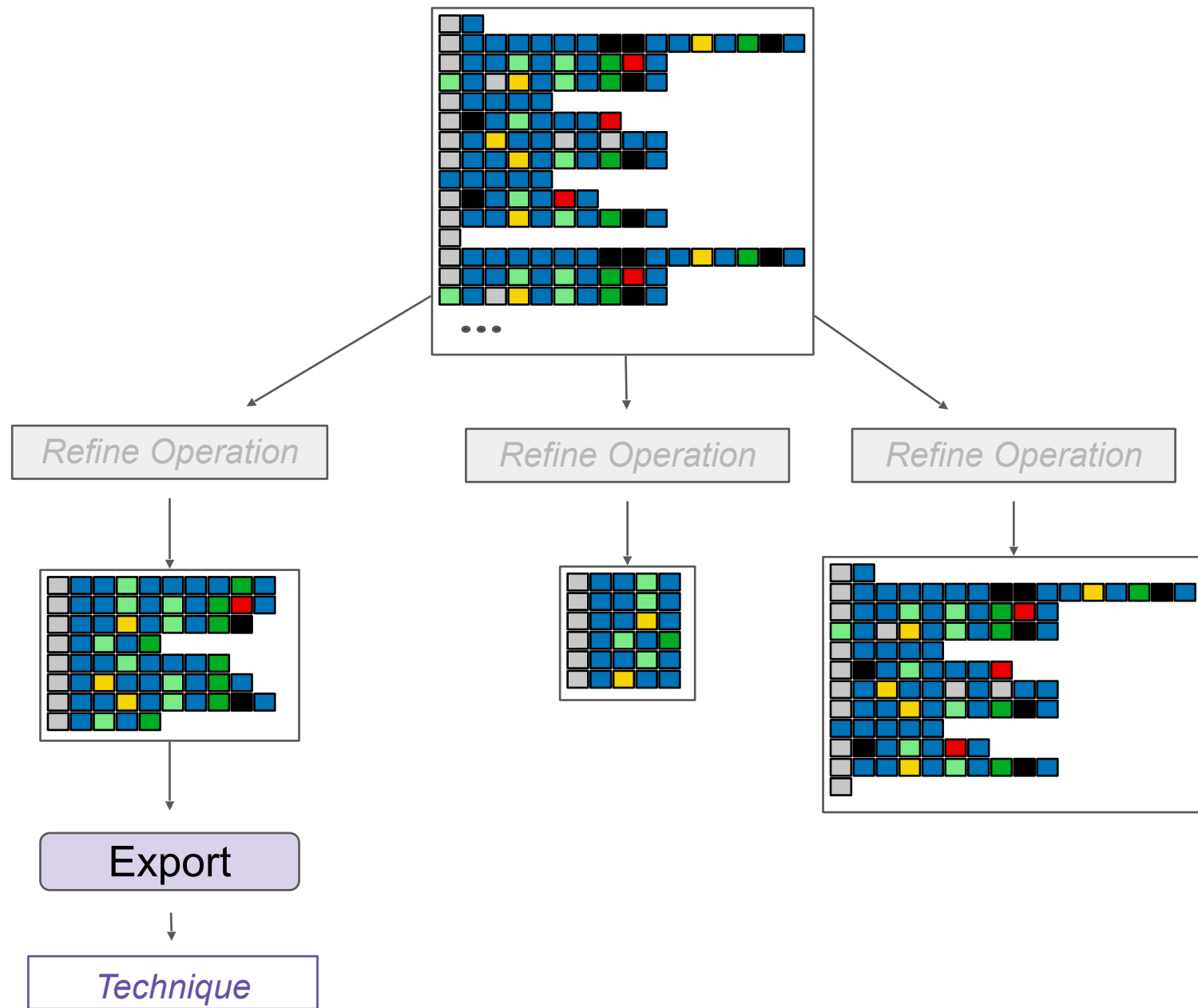

- Export refined segments for further downstream analysis, to more specific tools:
 - Pattern mining
 - Clustering

High-Level Segmentifier Analysis Model

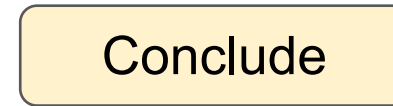
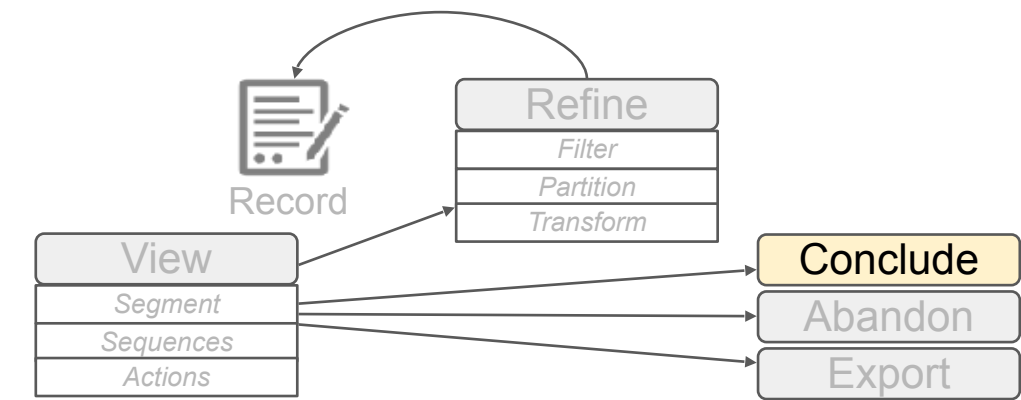
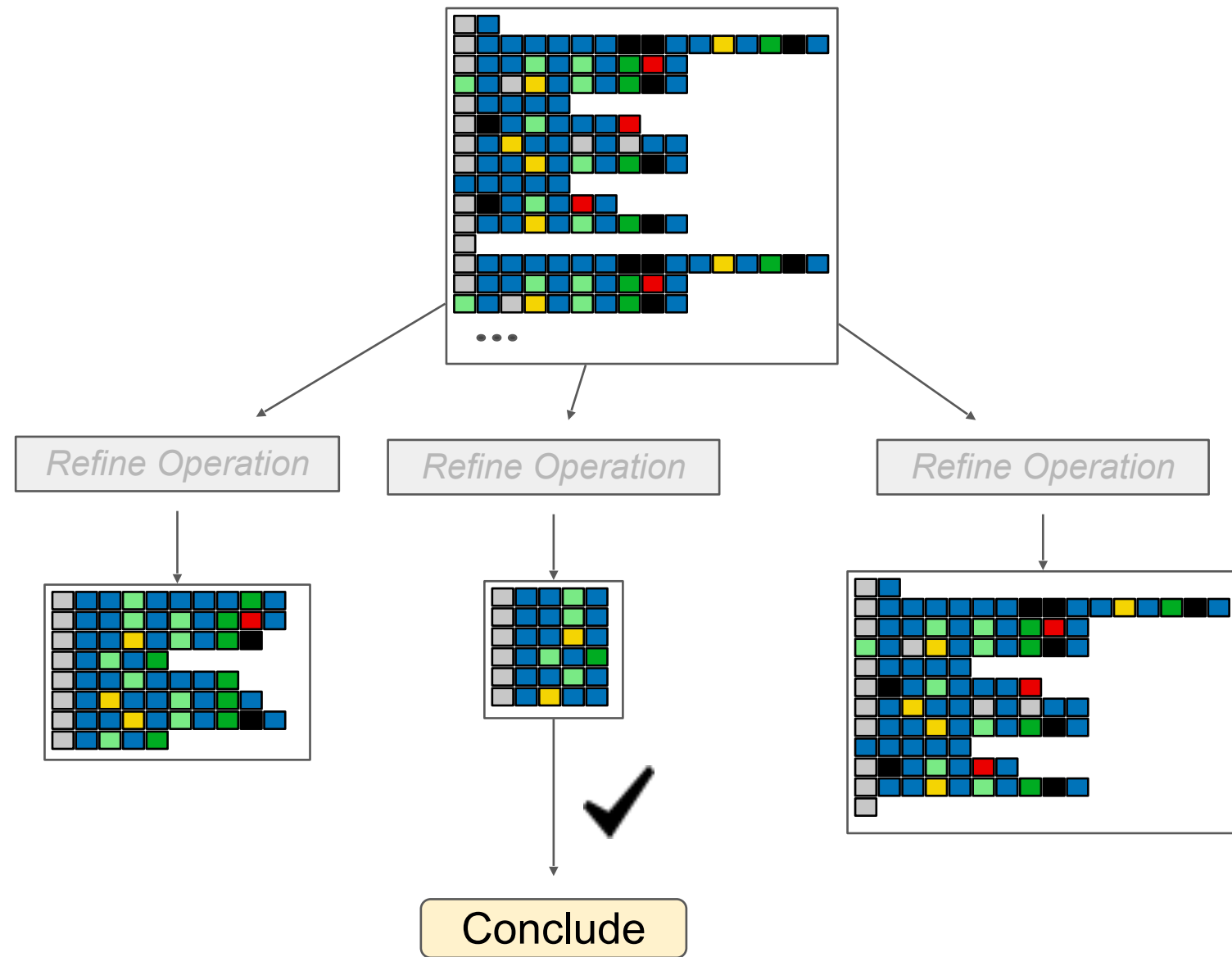

- Discover actionable insight by *viewing* segment

High-Level Segmentifier Analysis Model

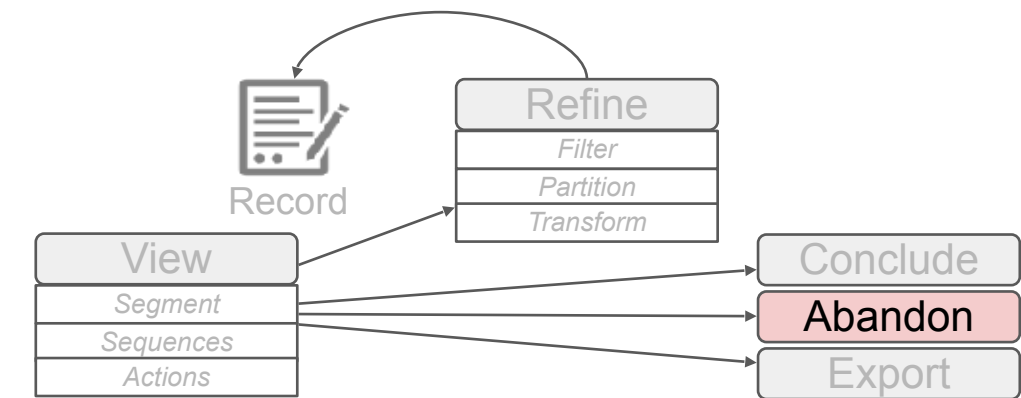

Abandon

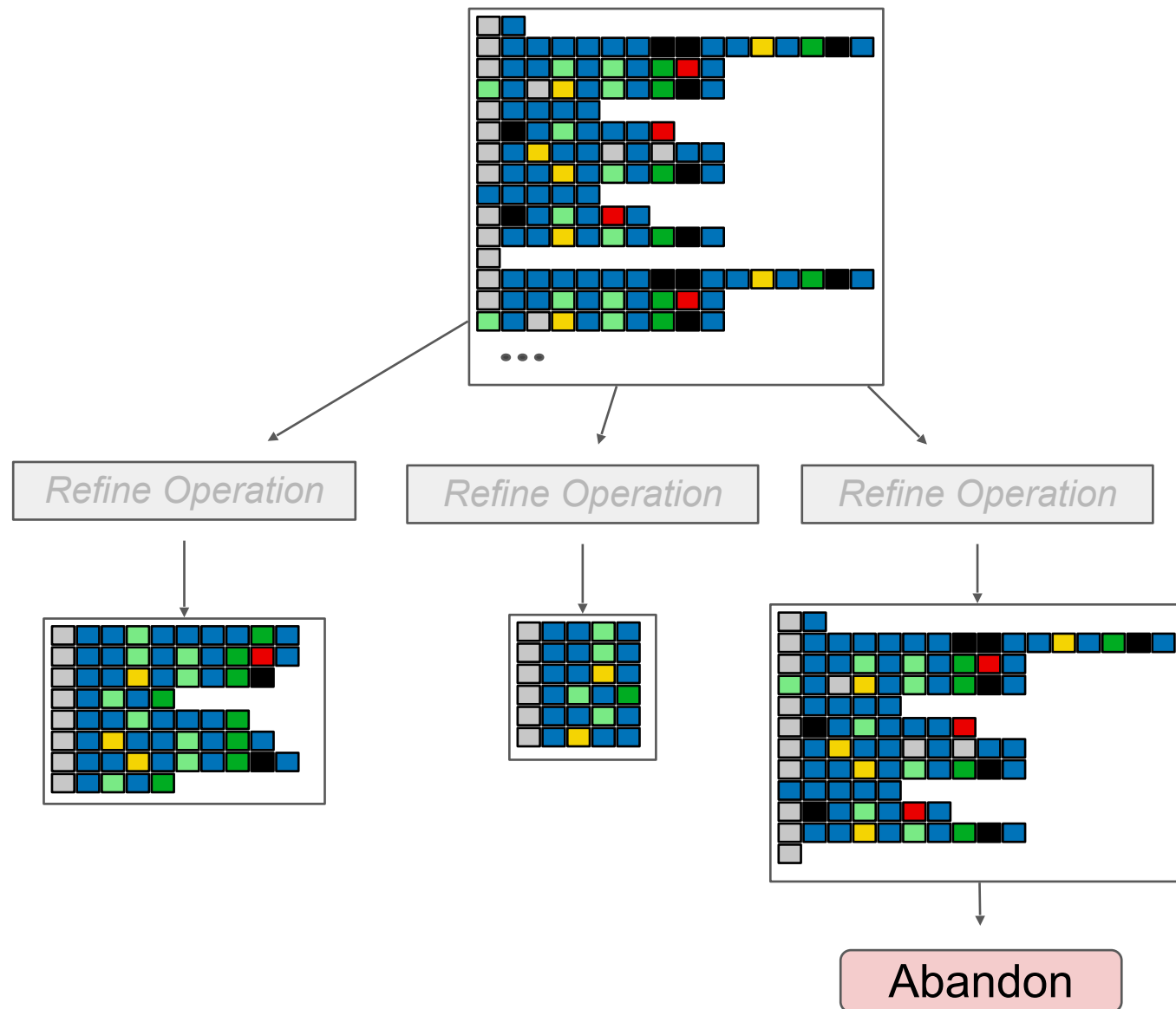

- By *viewing* the segment, analyst *abandons* if:
 - No actionable insights
 - No further ways to *refine*
 - Not suitable for *export*

Why Visual Analytics?

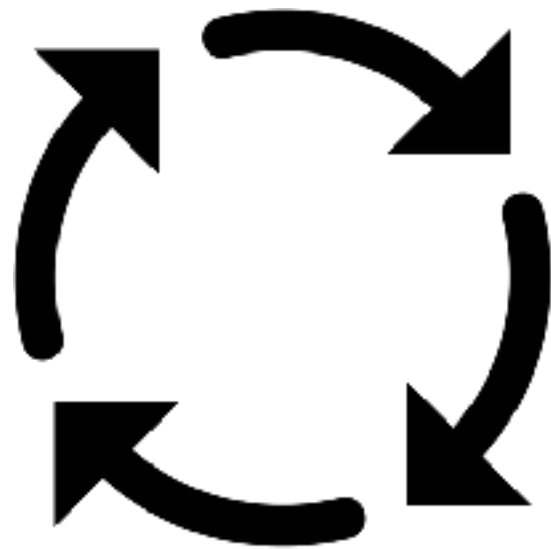

- Automation would be nice...
 - Put data in, actionable results appear
- ... but it is not realistic
 - Many possible questions, data-driven interplay between finding answers and generating new questions
- Human-in-the-loop visual data analysis
 - Integrate computing power of machine with intuition of domain experts

Solution

The Segmentifier Interface

The Segmentifier interface is divided into several main sections:

- Operation Manager:**
 - Buttons: Remove Operation, Clear All, Download Segment as CSV
 - Operation Inspector:** Shows a sequence of operations (Contains, Contains) and their results (e.g., # of songs, # of tracks).
 - Operation Builder:** Includes a visual flow diagram and a list of actions (e.g., addtoCart, purchase, search) with their respective counts and percentages.
- Analysis Paths:** A hierarchical tree diagram for 'D3_campaign_email_200K' showing various paths and their associated metrics.
- Segment Inspector:**
 - Plots:** Four charts showing Duration (s), # of songs, # of tracks, and Start Date (D).
 - Bar Charts:** Three charts showing # of songs, # of users, and # of songs.
- Actions:**
 - Number of Sequences That Contain Action:** A table listing actions and their frequency/percentage (e.g., addtoCart: 8,828, 100%).
 - Action Transition Network:** A graph showing relationships between actions.
 - Selected Action Adjacency View:** A detailed view of a specific action's neighbors.
- Sequence Details:** A table showing sequence details and a legend for action types.

Video

Segmentifier: Interactively Refining
Clickstream Data into Actionable
Segments



<https://www.youtube.com/watch?v=TobYDFeISOg&t=20s>

Segmentifier Contributions

- Thorough **characterization of task and data abstraction** for clickstream data analysis

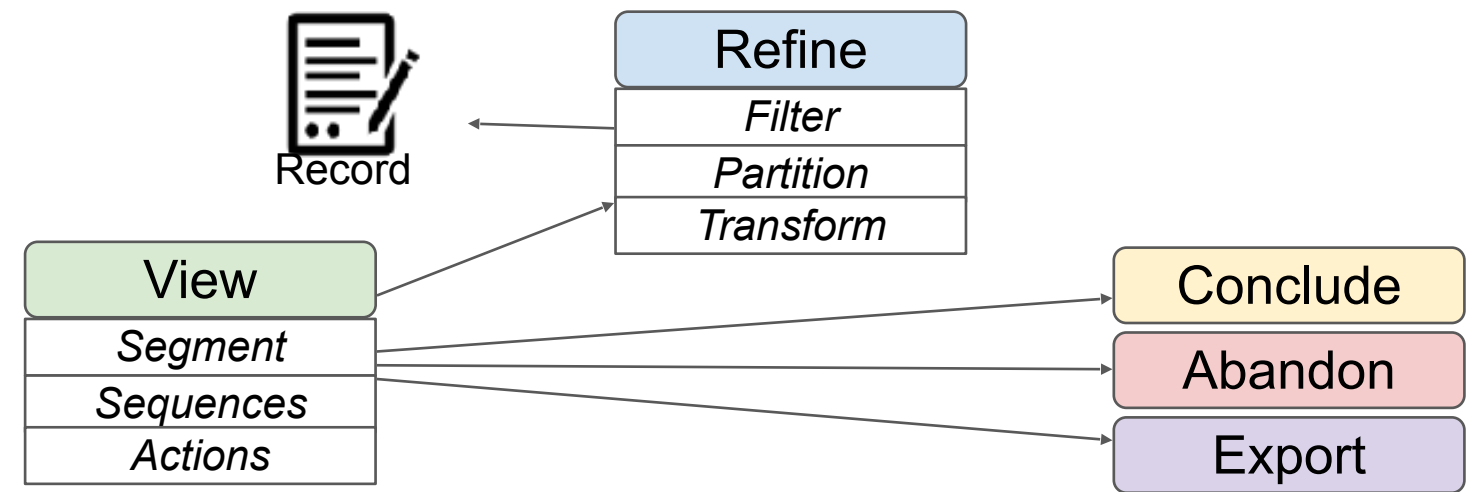

Segmentifier Contributions

- Thorough **characterization of task and data abstraction** for clickstream data analysis
- **Segmentifier: novel analytics interface** for refining data segments and viewing characteristics before downstream fine-grained analysis

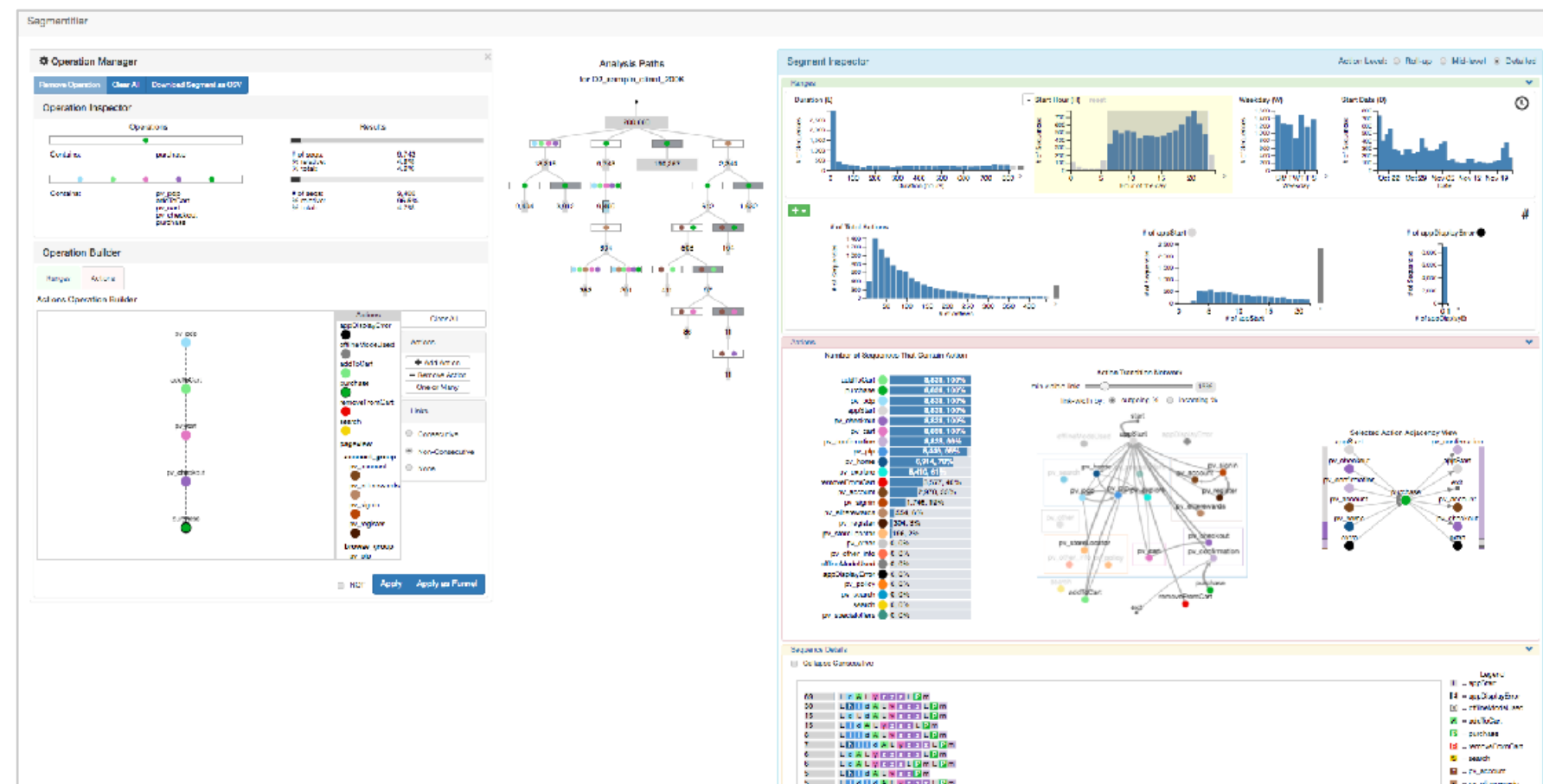

Segmentifier Contributions

- Thorough **characterization of task and data abstraction** for clickstream data analysis
- **Segmentifier: novel analytics interface** for refining data segments and viewing characteristics before downstream fine-grained analysis
- Preliminary **evidence of utility**

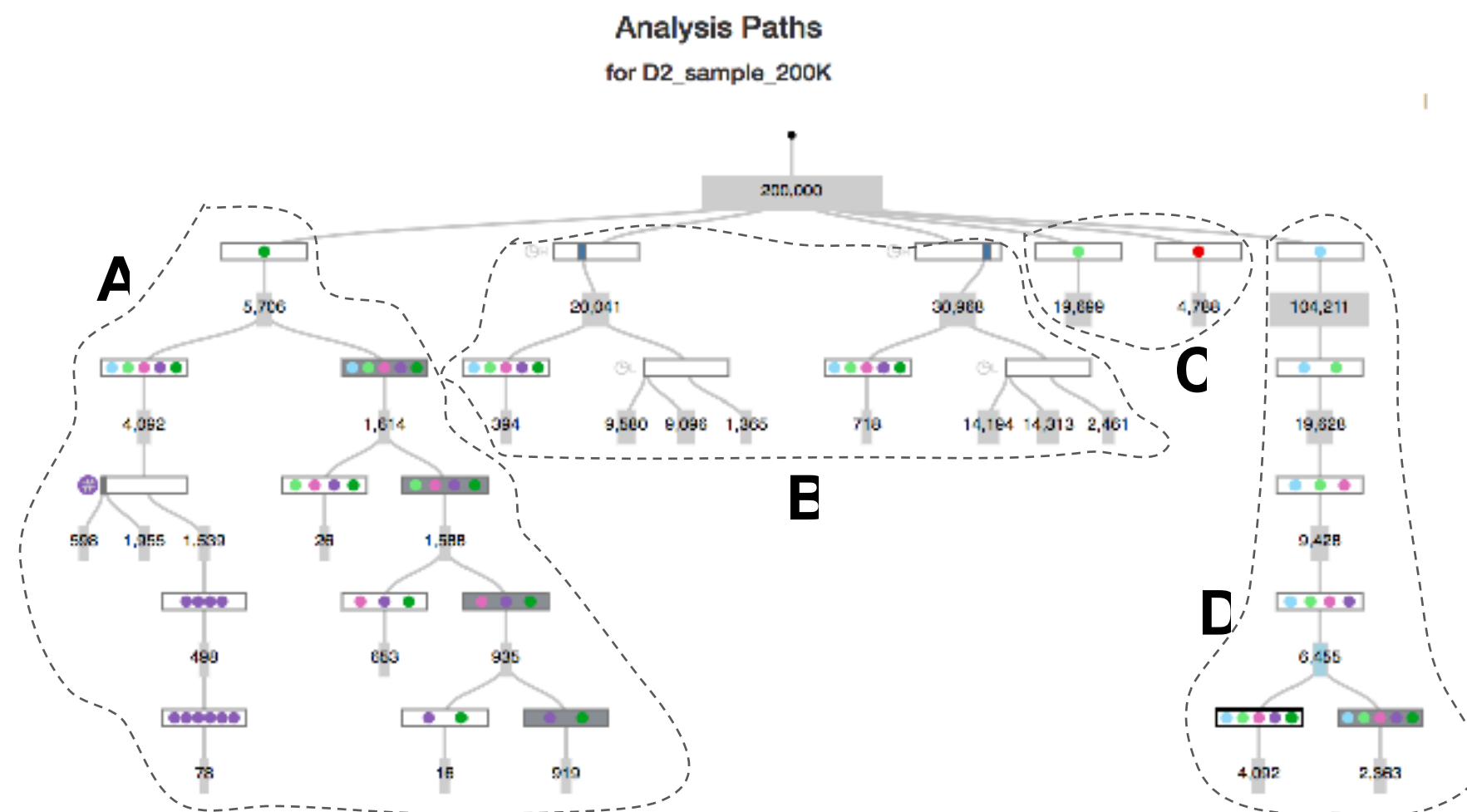

Three case studies of problem-driven work

- e-commerce



- facilities management



- biology





Michael
Oppermann



Ocupado

Visualizing Location-Based Counts Over Time Across Buildings

<http://www.cs.ubc.ca/labs/imager/tr/2020/ocupado/>

Ocupado: Visualizing Location-Based Counts Over Time Across Buildings.

Oppermann and Munzner. Computer Graphics Forum (Proc. EuroVis 2020) 39(3):127-138 2020.

Location-Based Counts





**Previous measurement required
physical counting or installation
of additional hardware.**

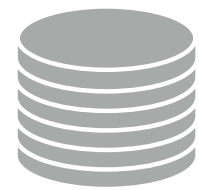

Previous measurement required physical counting or installation of additional hardware.

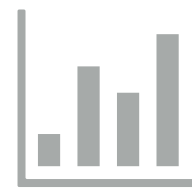

Previous visualization attempts were limited in space and time.



Design Study

WiFi Connections: Location-Based Counts

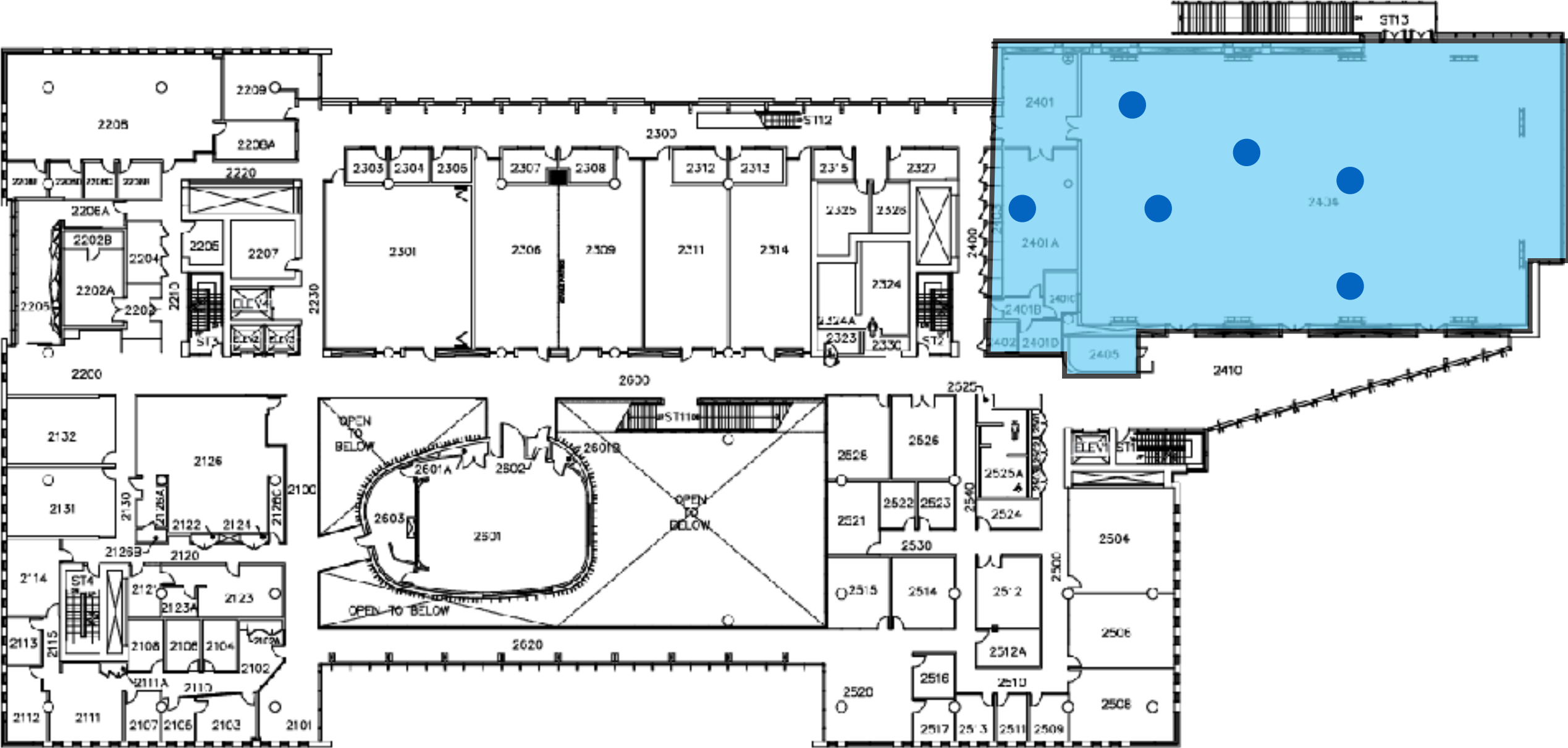

WiFi Connections: Location-Based Counts

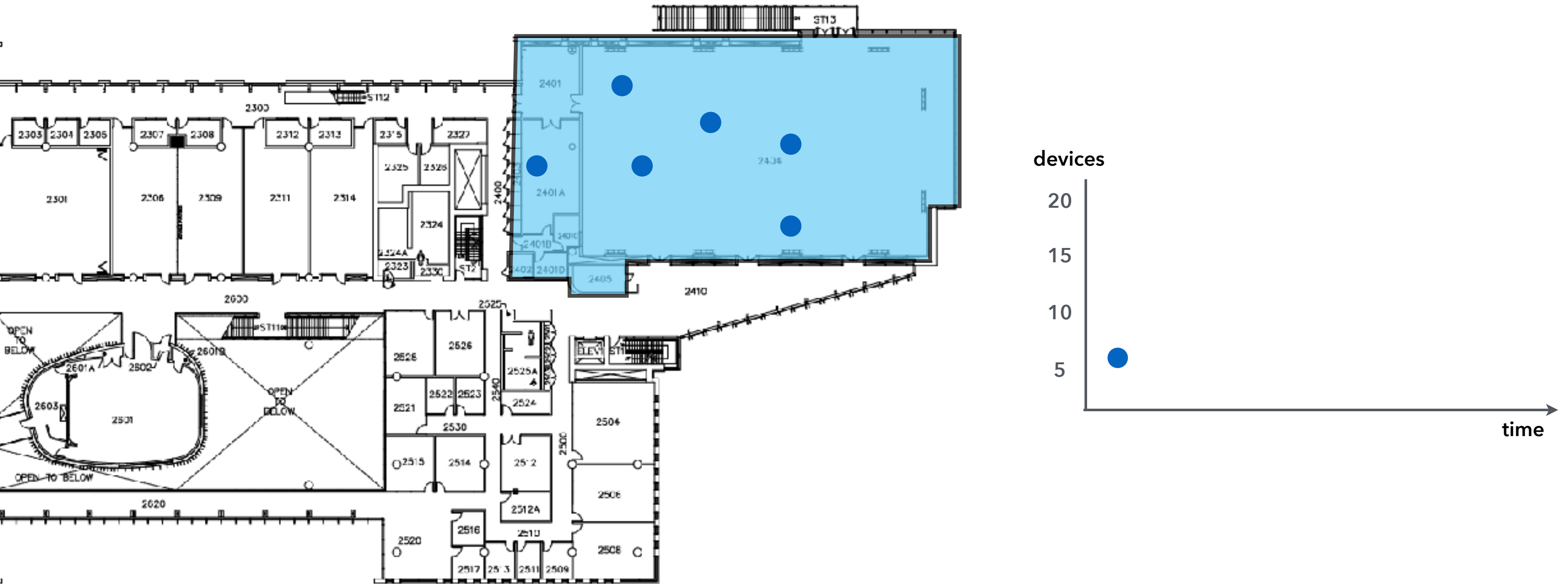

WiFi Connections: Location-Based Counts

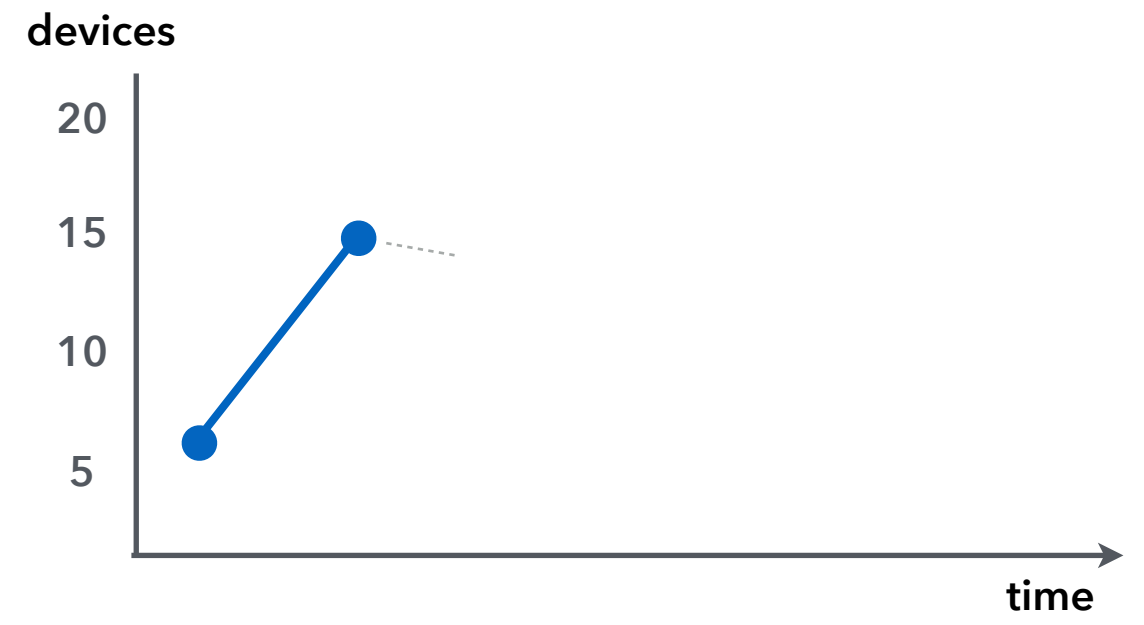
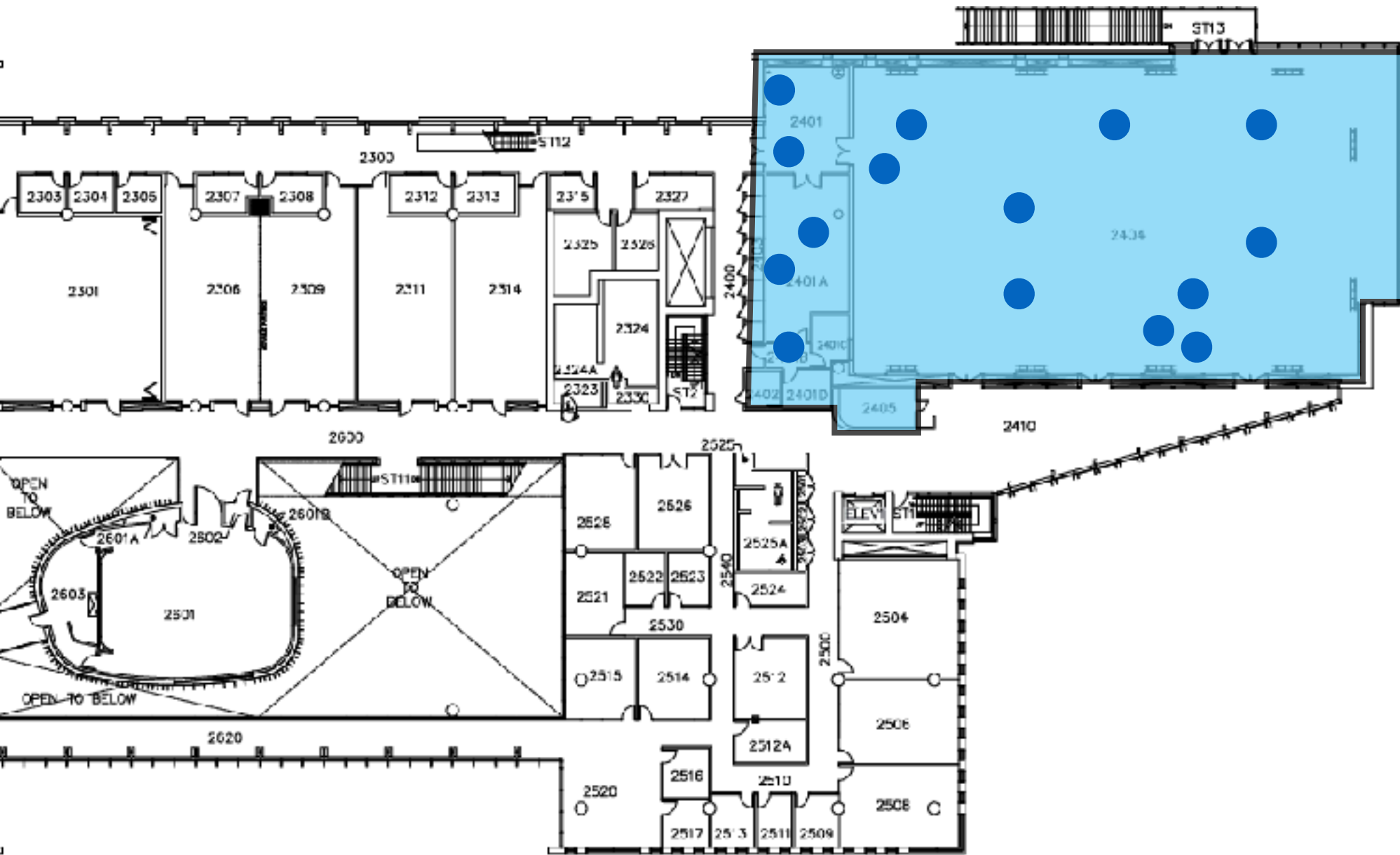

WiFi Connections: Location-Based Counts

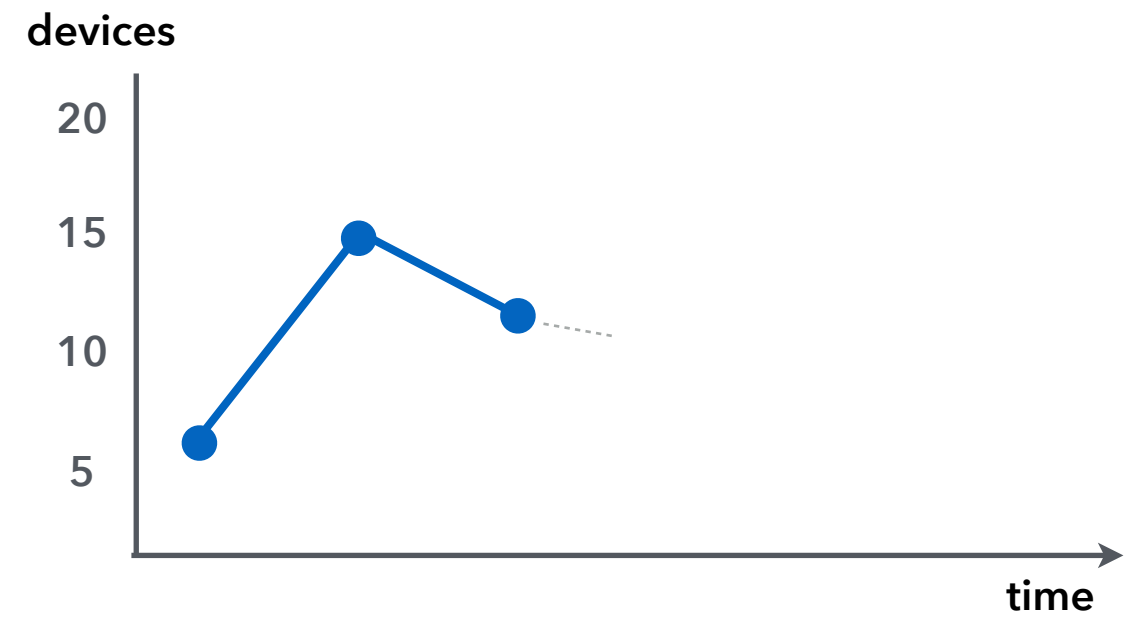
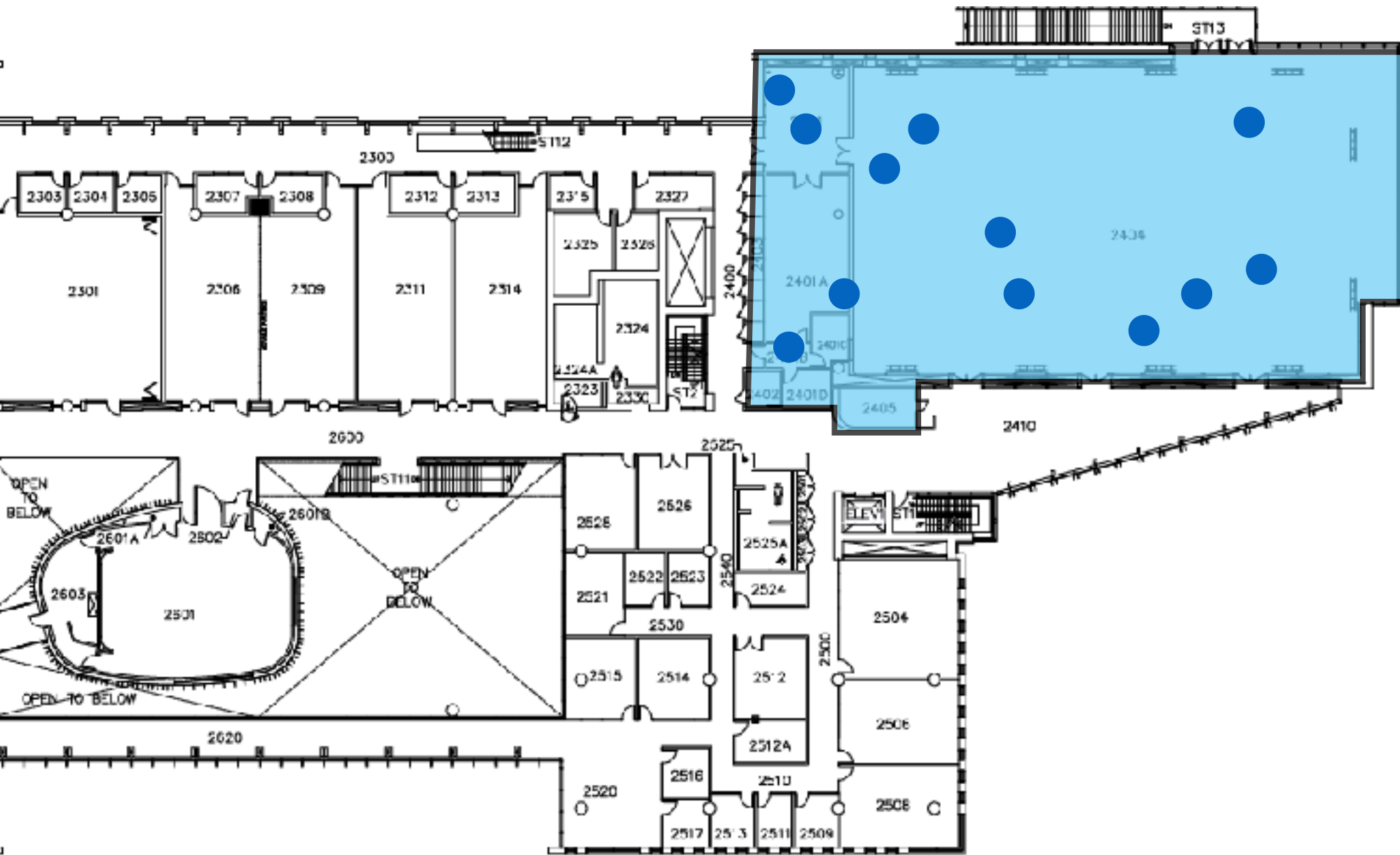

WiFi Connections: Location-Based Counts

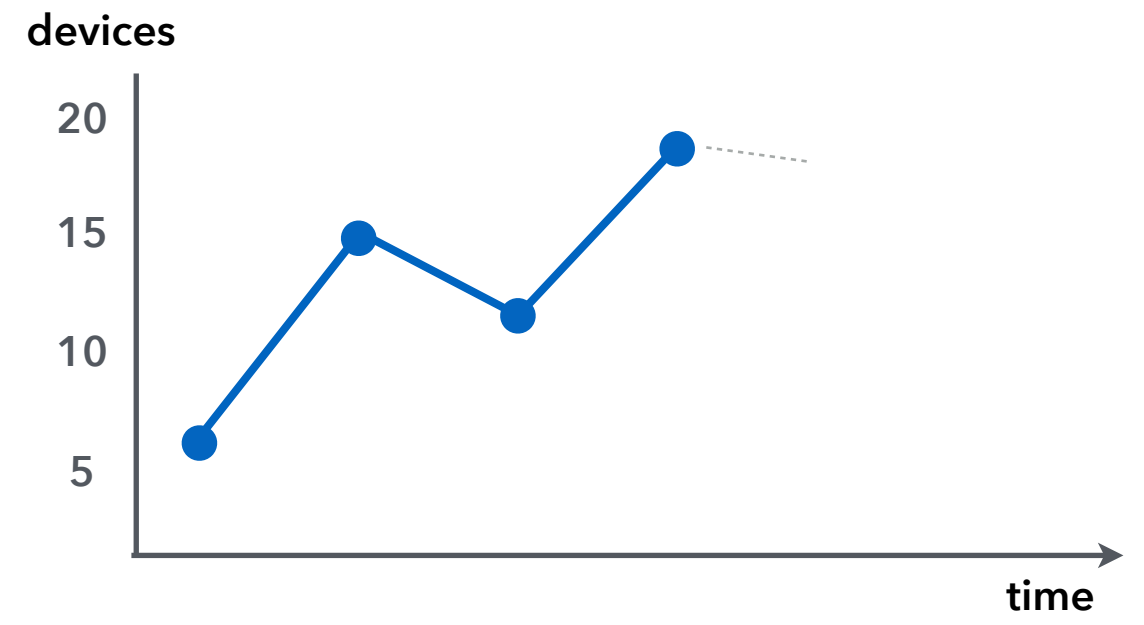
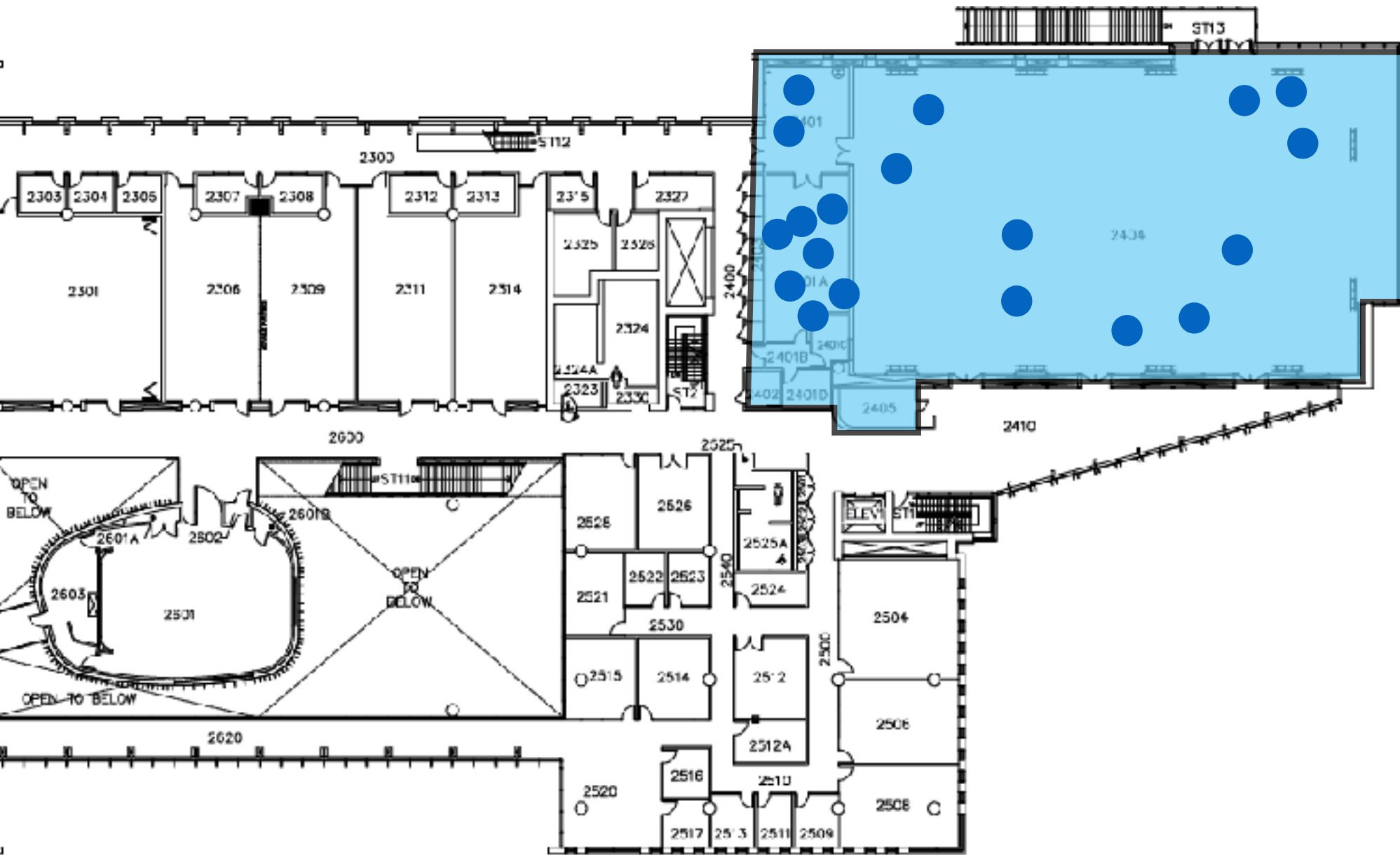

WiFi Connections: Location-Based Counts

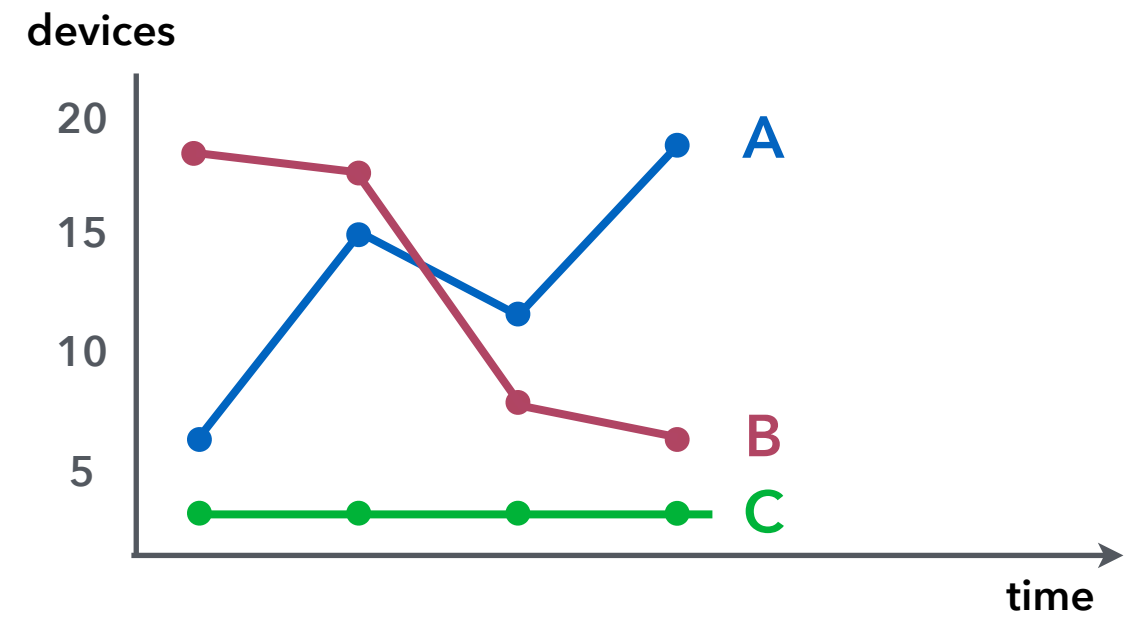

WiFi Connections: Location-Based Counts



Location-Based Counts

- ▶ **Regular intervals (e.g., every 5 minutes)**
- ▶ **Spatial hierarchy (Zone → Floor → Building → Campus)**
- ▶ **No trajectories or device identifiers are recorded**
- ▶ **Intrinsic privacy advantages**

Data



**Automated
HVAC control**

Data

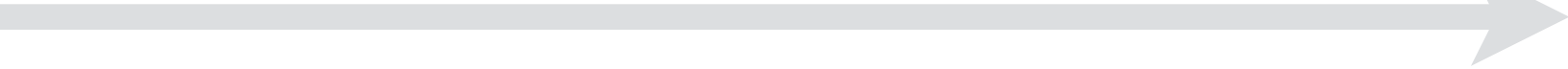

Data



Decision making

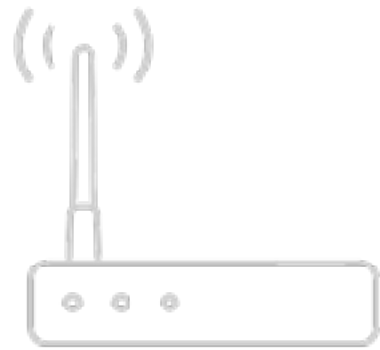

WiFi connections as a proxy for occupancy



WiFi connections as a proxy for occupancy

Interviews with potential stakeholders

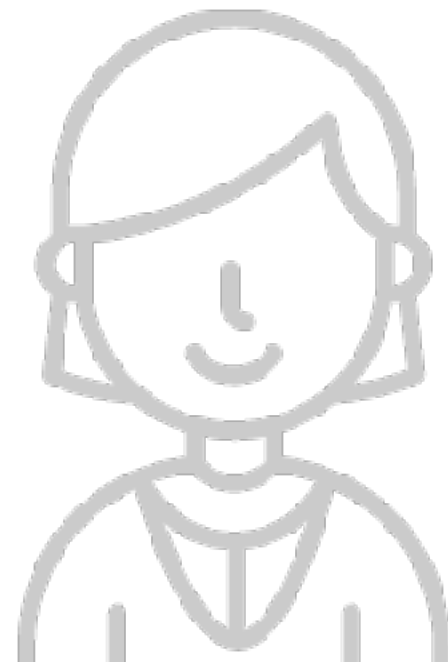
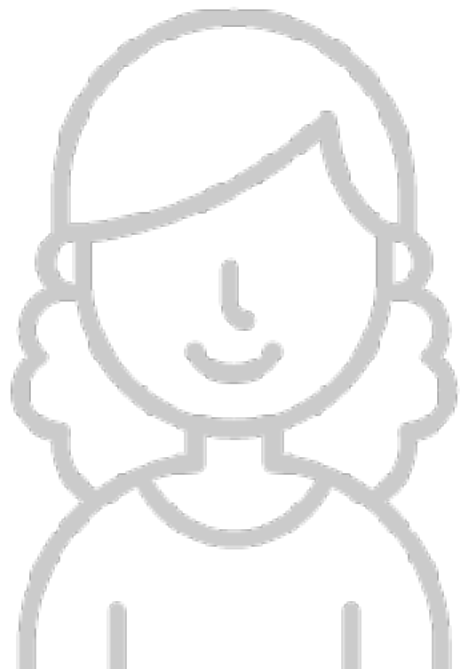

Focus Domains

- ▶ **Space planning**
- ▶ **Building management**
- ▶ **Custodial services**
- ▶ **Classroom management**
- ▶ **Data quality control**

Focus Domains

- ▶ Space planning
- ▶ Building management
- ▶ Custodial services
- ▶ Classroom management
- ▶ Data quality control



**Semi-structured discussions
and live demos**

Tasks



Confirm assumptions or previous observations.

Do students occupy room x in evenings or on weekends?

Tasks

- Confirm assumptions or previous observations.**
- Monitor the current/recent utilization rate.**
Which rooms are empty/busy?

Tasks

- Confirm assumptions or previous observations.**
- Monitor the current/recent utilization rate.**
- Communicate space usage and justify decisions.**
Space usage improved after renovation.

Tasks

- Confirm assumptions or previous observations.**
- Monitor the current/recent utilization rate.**
- Communicate space usage and justify decisions.**
- Validate the data (quality control).**
Check minimum size of a room that can be captured.

Spatial and Temporal Data Granularities

Visualization Prototypes



Time

Visualization Prototypes

Sandbox

Data sketches,
static data export

- ▶ **original plan: different interface for each stakeholder**
- ▶ **realization: task & data abstractions match multiple stakeholders**
- ▶ **if slice by space & time granularity**

Spatial and Temporal Data Granularities

Regions of interest

Zone

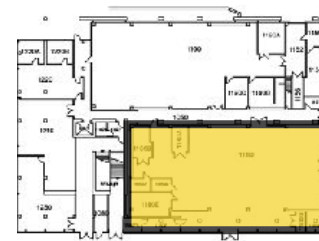

Floor

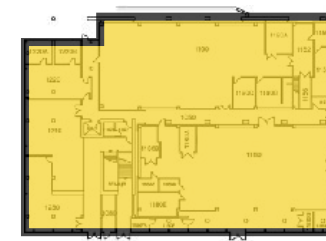

Building

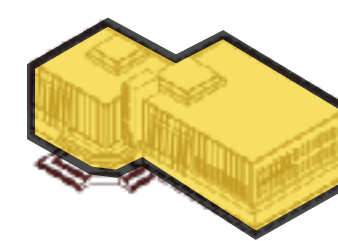

Spatial and Temporal Data Granularities

Regions of interest



Periods of interest

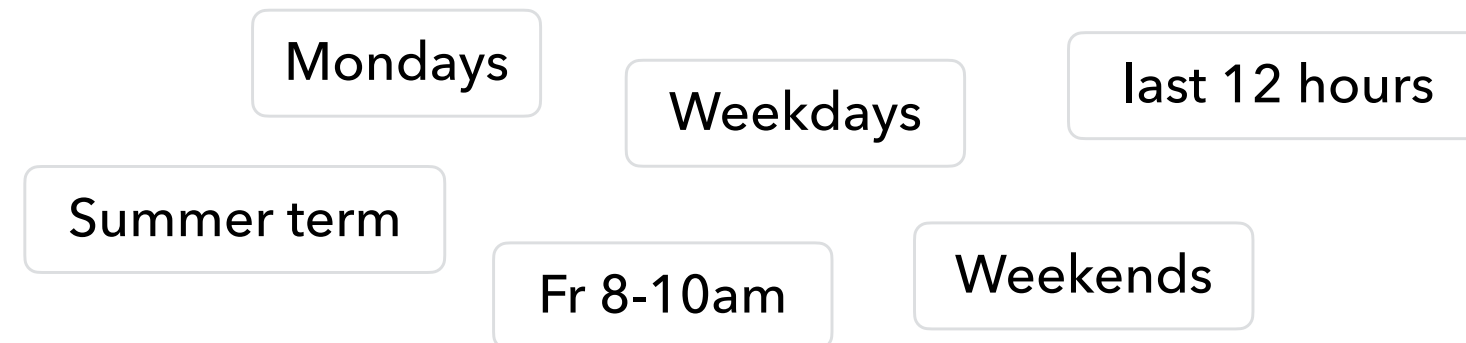

Visualization Prototypes

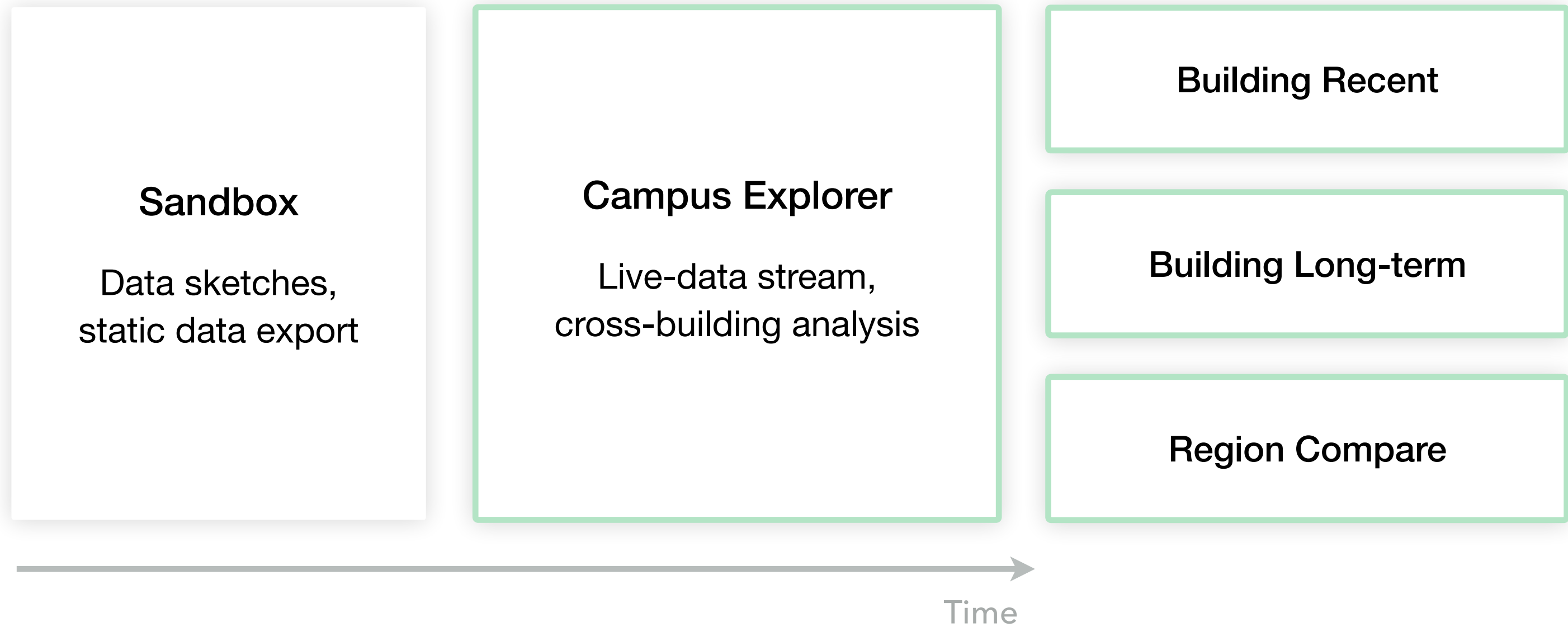

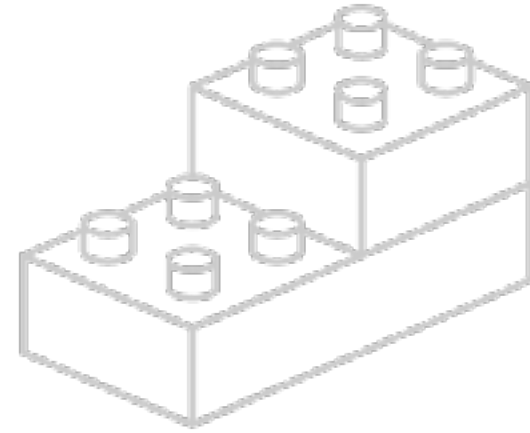

Reusable Visualization Components

Reusable Visualization Components

Layout

Visual Encoding

Facet

Comparisons

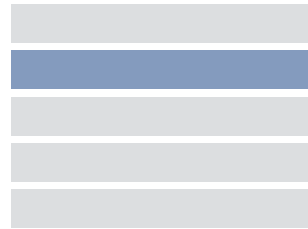

Sparkline







Juxtaposition

Repeating patterns, trends, outliers
(contiguous)



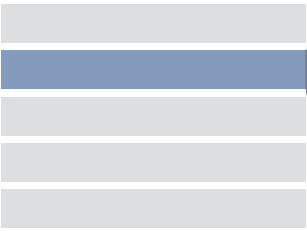

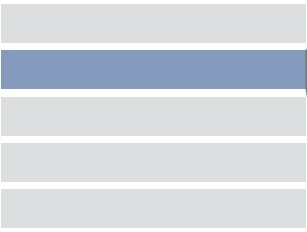
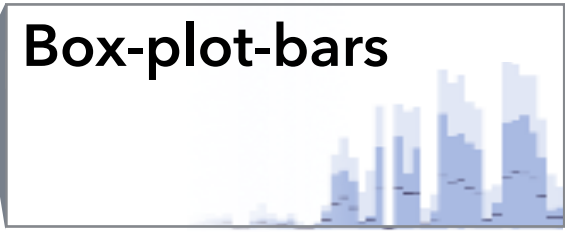
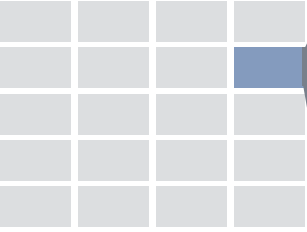
Reusable Visualization Components

Layout	Visual Encoding	Facet	Comparisons
	Sparkline 	Juxtaposition	Repeating patterns, trends, outliers (contiguous)
	Box-plot-bars 	Juxtaposition	Repeating patterns, trends, outliers (<i>non-contiguous</i>)



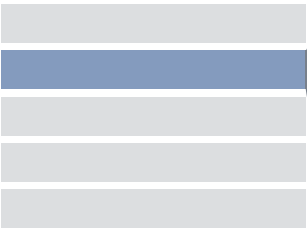

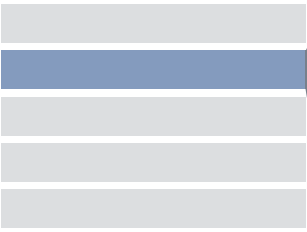
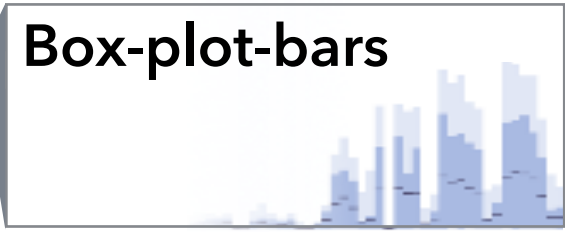
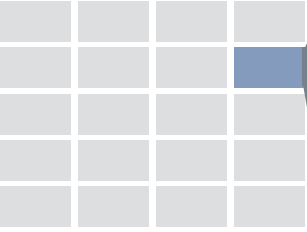
Reusable Visualization Components

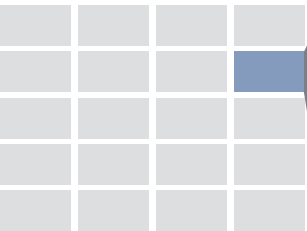
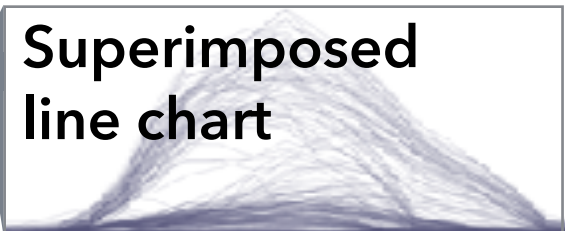
Layout	Visual Encoding	Facet	Comparisons
	Sparkline 	Juxtaposition	Repeating patterns, trends, outliers (contiguous)
	Box-plot-bars 	Juxtaposition	Repeating patterns, trends, outliers (<i>non-contiguous</i>)
	Confidence band line chart 	Aggregation	Typical utilization profiles



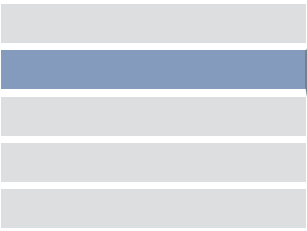

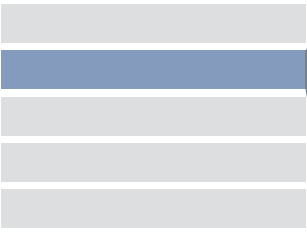
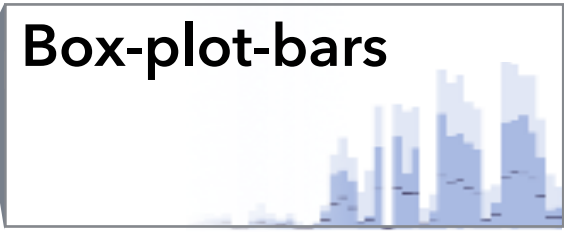
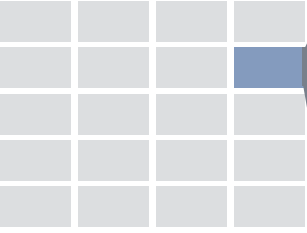
Reusable Visualization Components

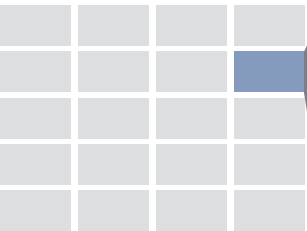
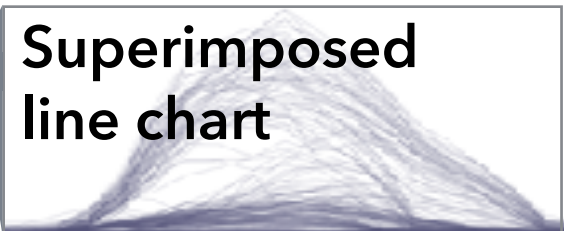
Layout	Visual Encoding	Facet	Comparisons
	Sparkline 	Juxtaposition	Repeating patterns, trends, outliers (contiguous)
	Box-plot-bars 	Juxtaposition	Repeating patterns, trends, outliers (<i>non-contiguous</i>)
	Confidence band line chart 	Aggregation	Typical utilization profiles
	Superimposed line chart 	Superposition	Within-session patterns, outliers

Reusable Visualization Components

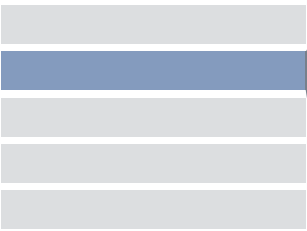
	Layout	Visual Encoding	Facet	Comparisons
<i>Temporal</i>		Sparkline 	Juxtaposition	Repeating patterns, trends, outliers (contiguous)
		Box-plot-bars 	Juxtaposition	Repeating patterns, trends, outliers (<i>non-contiguous</i>)
		Confidence band line chart 	Aggregation	Typical utilization profiles
		Superimposed line chart 	Superposition	Within-session patterns, outliers

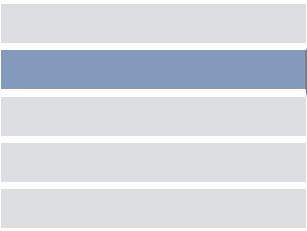
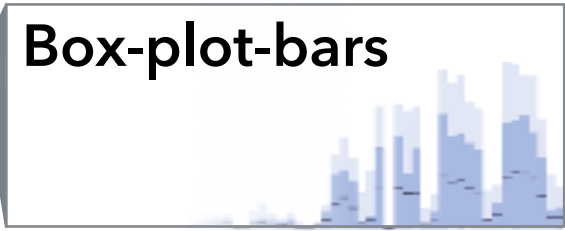
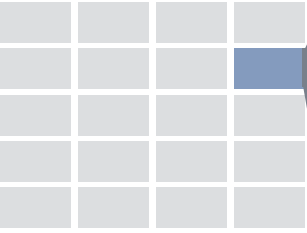
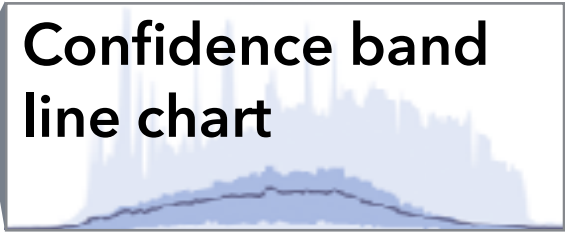
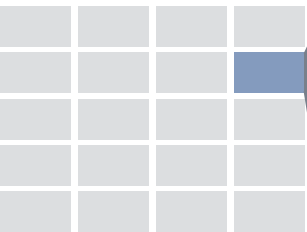
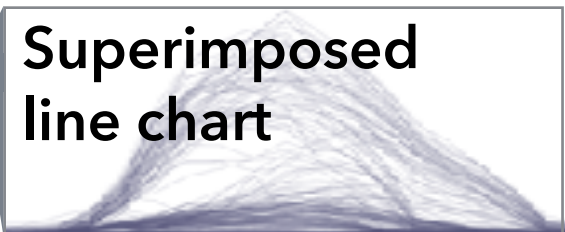
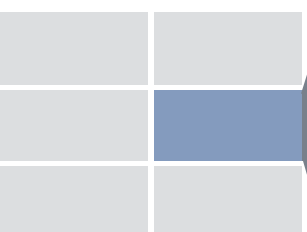
Reusable Visualization Components

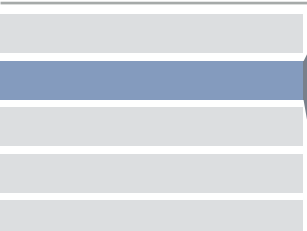
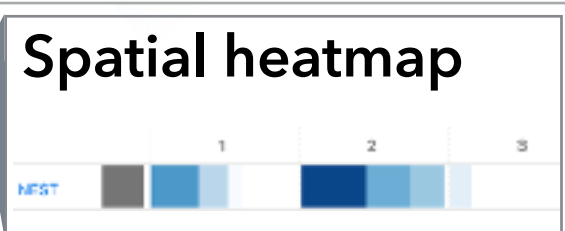
	Layout	Visual Encoding	Facet	Comparisons
<i>Temporal</i>		 Sparkline	Juxtaposition	Repeating patterns, trends, outliers (contiguous)
		 Box-plot-bars	Juxtaposition	Repeating patterns, trends, outliers (<i>non-contiguous</i>)
		 Confidence band line chart	Aggregation	Typical utilization profiles
		 Superimposed line chart	Superposition	Within-session patterns, outliers
<i>Spatial</i>		 Floor plan with symbols	Superposition	Within local spatial neighborhood
		 Spatial heatmap	Containment (nested)	Across distributed regions

Ocupado Interfaces

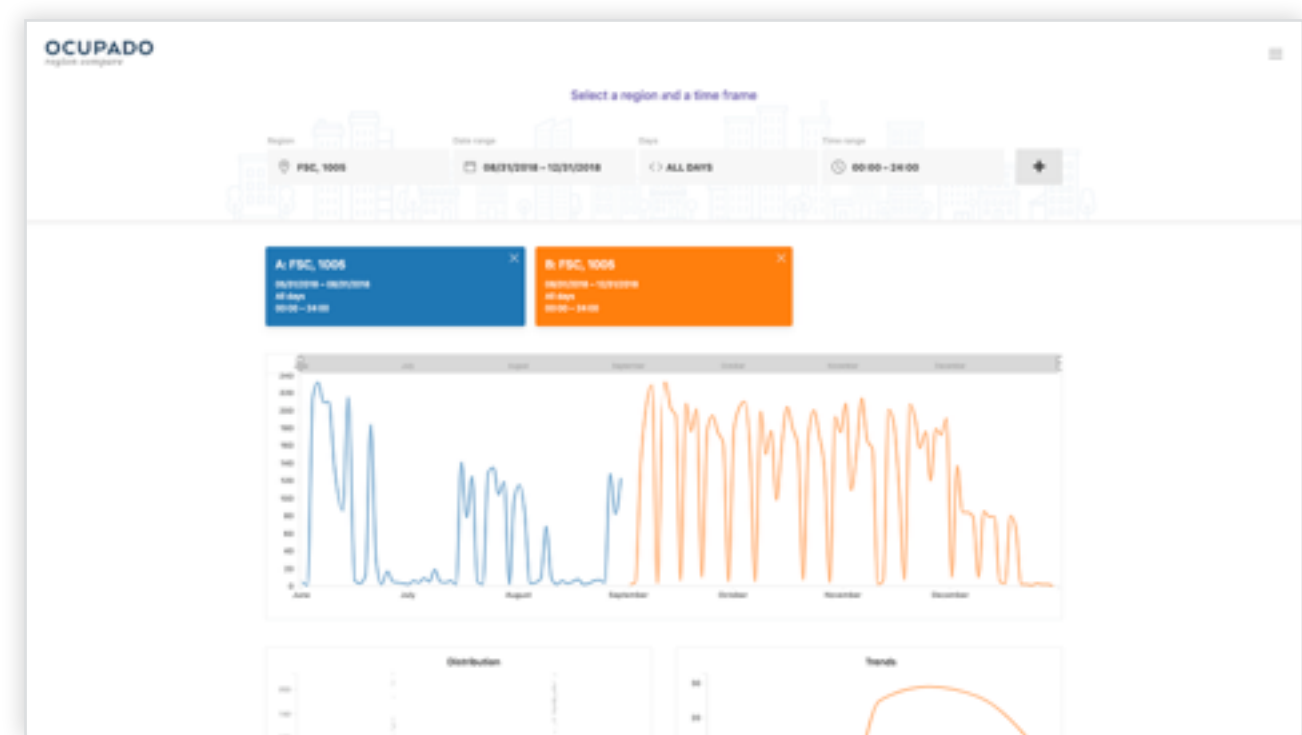
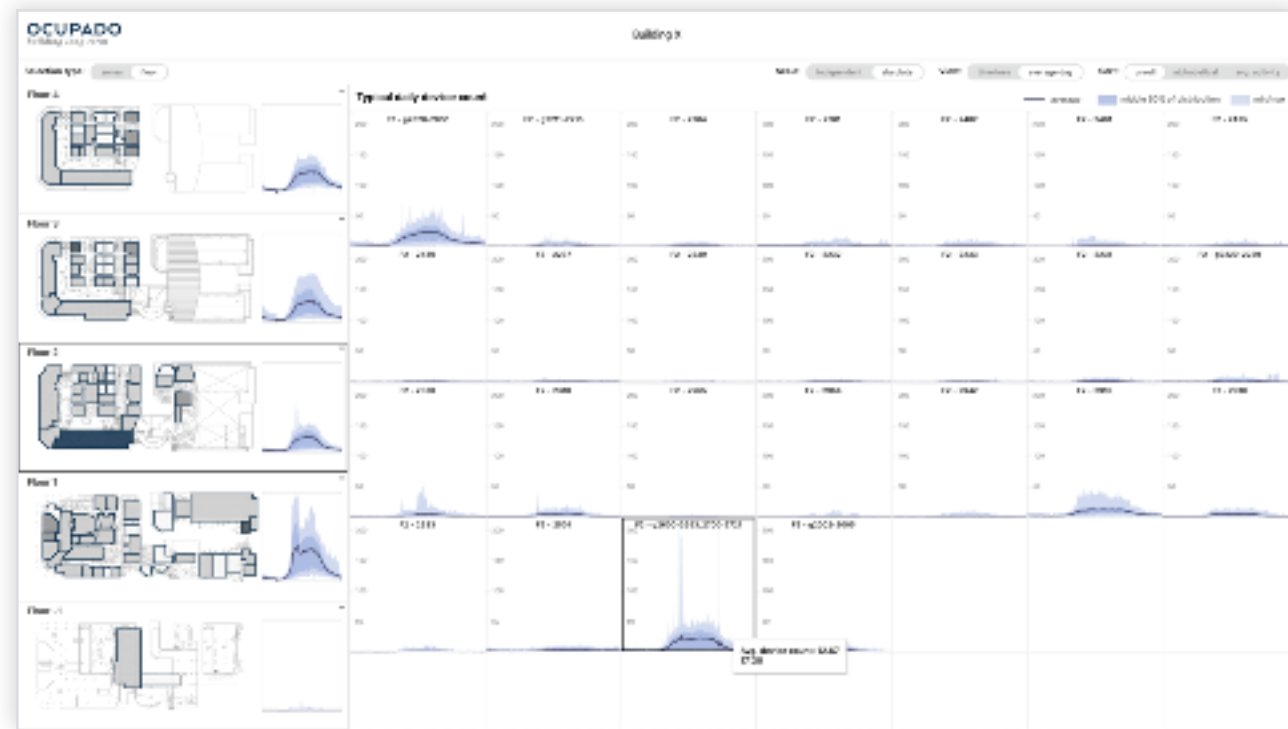

Ocupado Contributions

- ▶ Analysis and abstraction of data and tasks for studying space utilization
- ▶ Ocupado, a set of visual decision support tools
- ▶ Generalizable design choices for visualizing non-trajectory spatiotemporal data relating to large-scale indoor environments

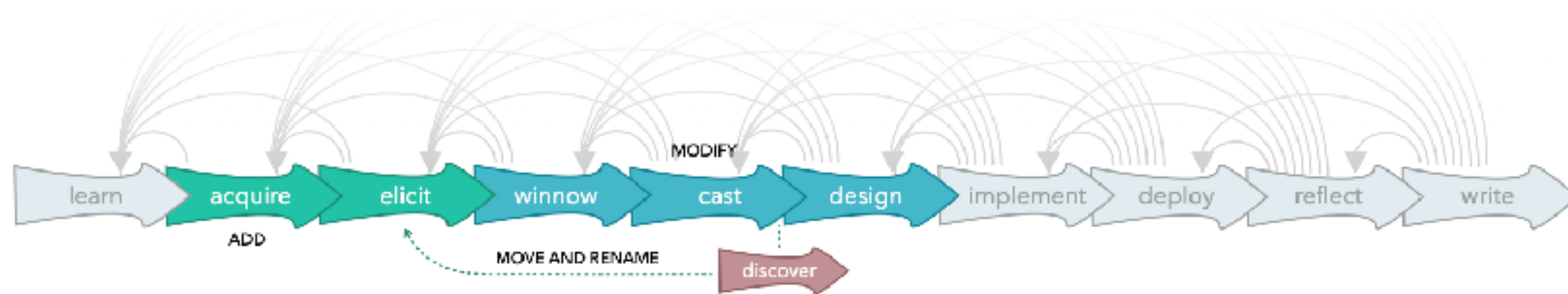
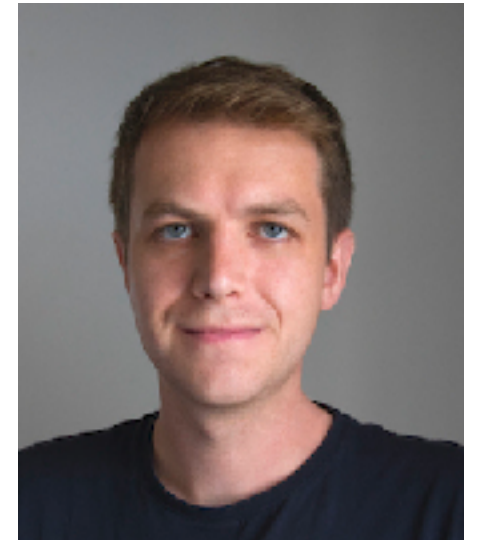

Data-First Design Studies

<http://www.cs.ubc.ca/group/infovis/pubs/2020/data-first/>

Data-First Design Studies.

Oppermann and Munzner. Proc. IEEE VIS BELIV Workshop 2020.

Original DSM framework



Original DSM framework



Data-first DSM framework



Original DSM framework



Data-first DSM framework

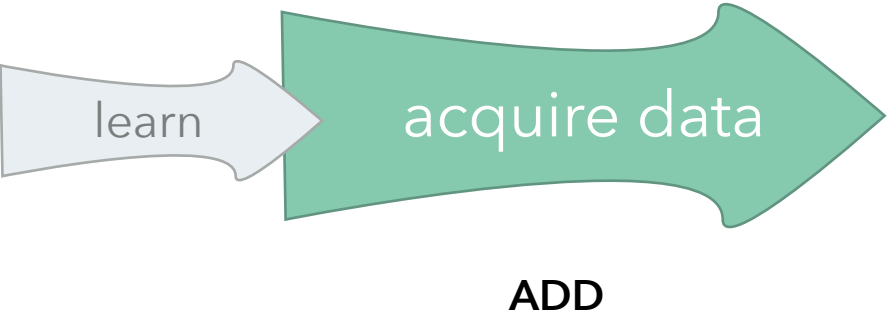

Original DSM framework



Data-first DSM framework

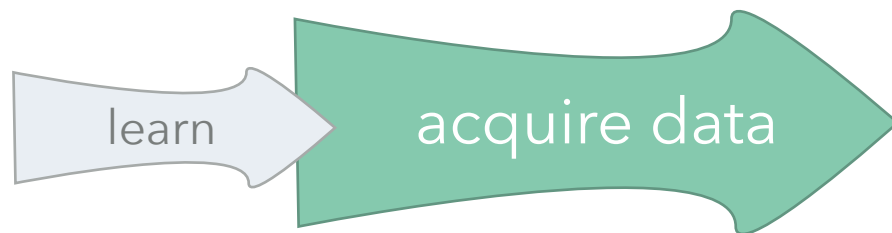

ADD

- ▶ What type of data am I working with?

Original DSM framework



Data-first DSM framework

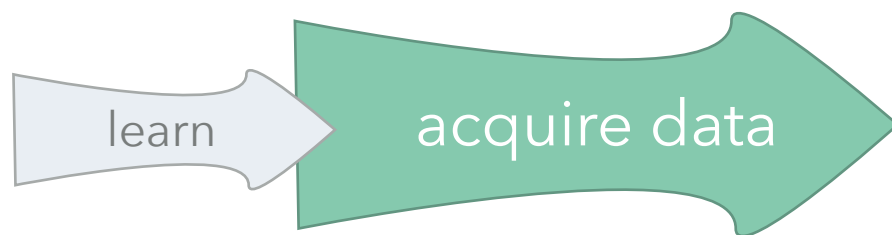

ADD

- ▶ What type of data am I working with?
- ▶ Are there any data quality challenges?

Original DSM framework



Data-first DSM framework

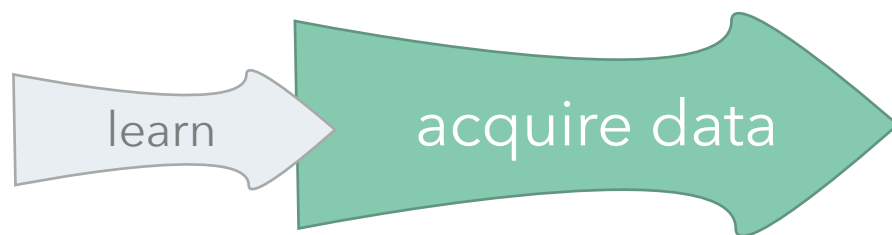

ADD

- ▶ What type of data am I working with?
- ▶ Are there any data quality challenges?
- ▶ What is special about this data?

Original DSM framework



Data-first DSM framework

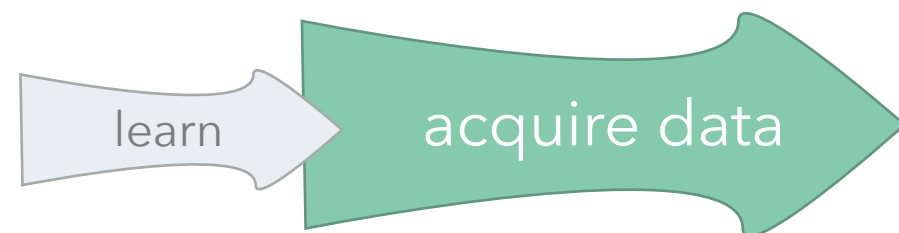

ADD

- ▶ What type of data am I working with?
- ▶ Are there any data quality challenges?
- ▶ What is special about this data?
- ▶ Who would benefit from seeing and exploring it?

Original DSM framework



MOVE AND RENAME

Data-first DSM framework

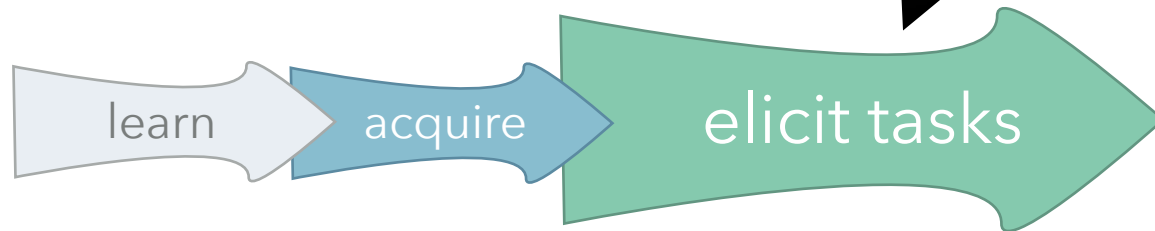

Original DSM framework



MOVE AND RENAME

Data-first DSM framework

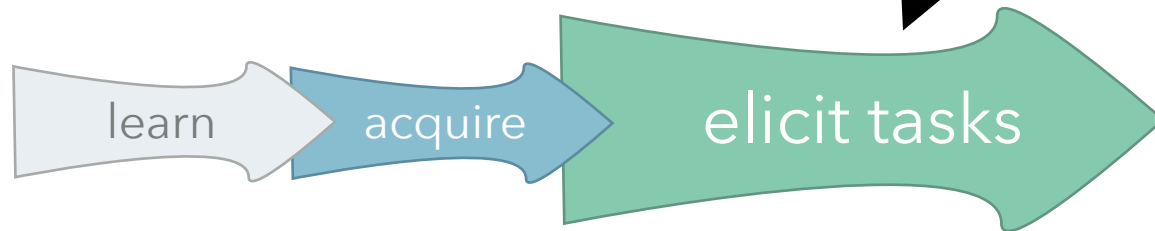

- ▶ Multiple potential stakeholders

Original DSM framework



MOVE AND RENAME

Data-first DSM framework

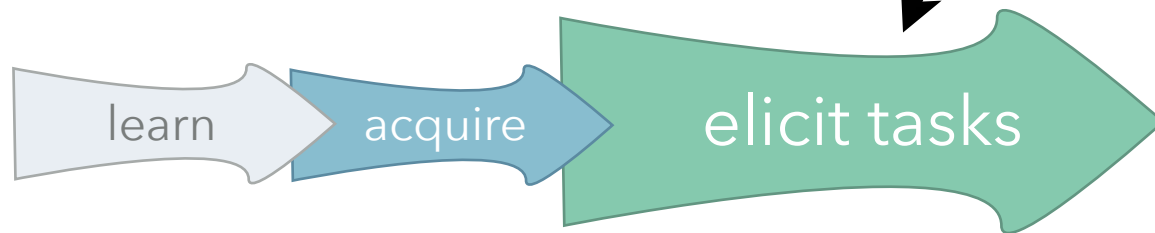

- ▶ Multiple potential stakeholders
- ▶ Explain initial data abstractions

Original DSM framework



MOVE AND RENAME

Data-first DSM framework

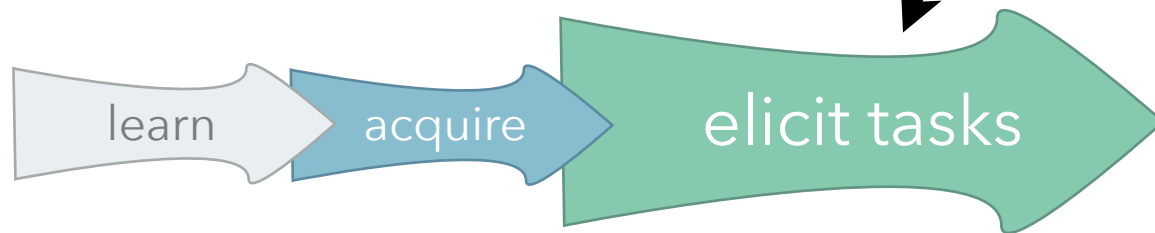

- ▶ Multiple potential stakeholders
- ▶ Explain initial data abstractions
- ▶ Learn about unsolved stakeholder needs

Original DSM framework



Data-first DSM framework

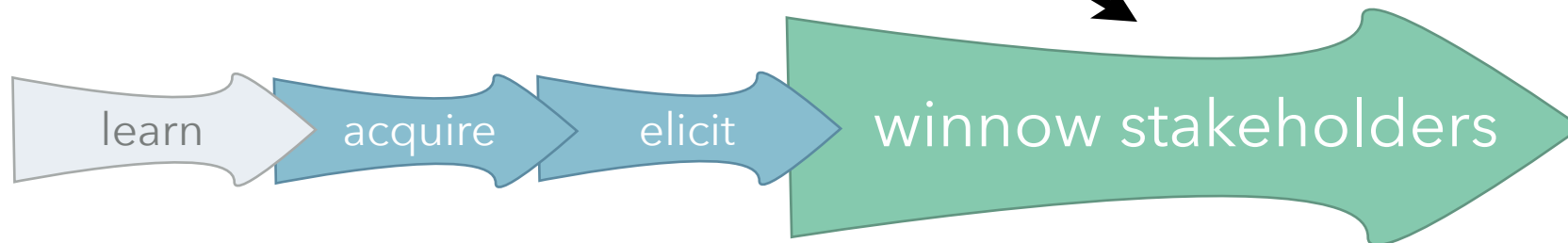

MODIFY

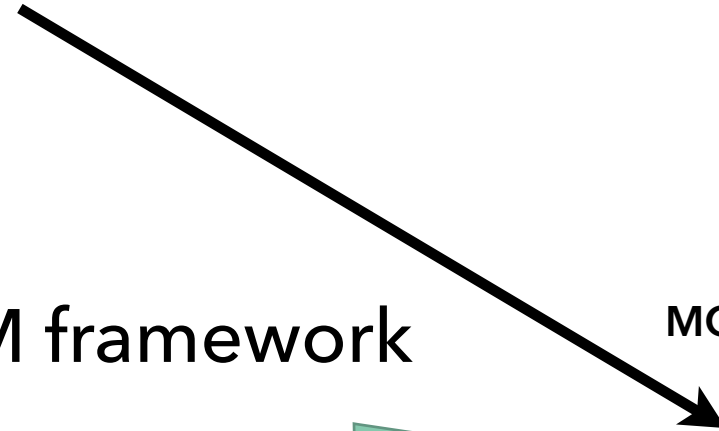

Original DSM framework



Data-first DSM framework

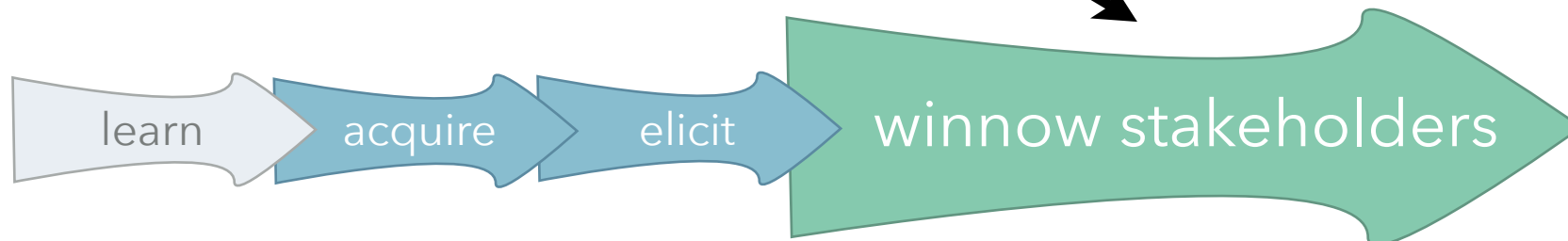

- ▶ How frequent are their data-relevant tasks?

Original DSM framework



Data-first DSM framework

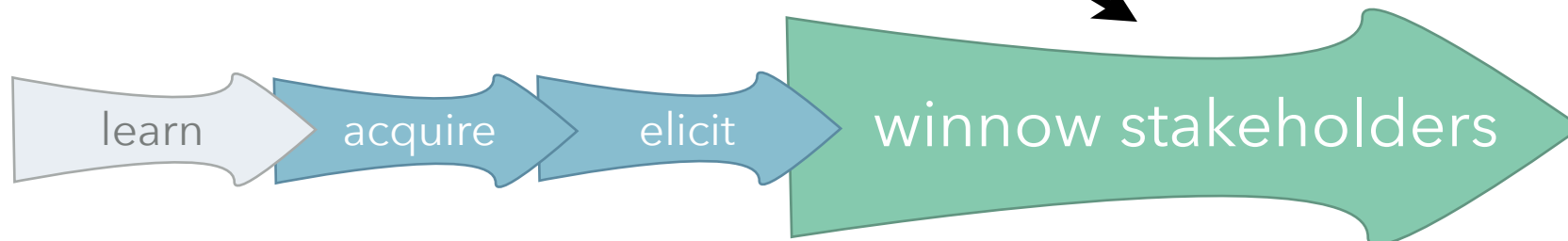

- ▶ How frequent are their data-relevant tasks?
- ▶ How central are these tasks to the stakeholder's primary mission?

Original DSM framework



Data-first DSM framework

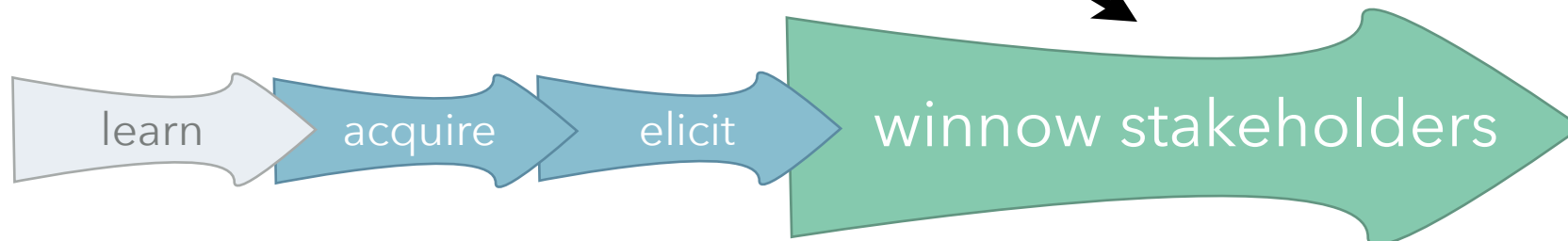

- ▶ How frequent are their data-relevant tasks?
- ▶ How central are these tasks to the stakeholder's primary mission?
- ▶ How many people in the organization deal with these tasks?

Original DSM framework

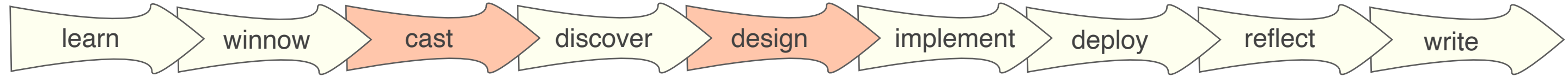

Data-first DSM framework

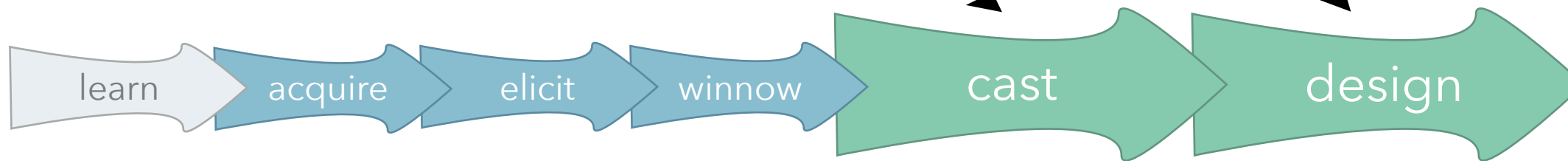

MODIFY

Original DSM framework



Data-first DSM framework

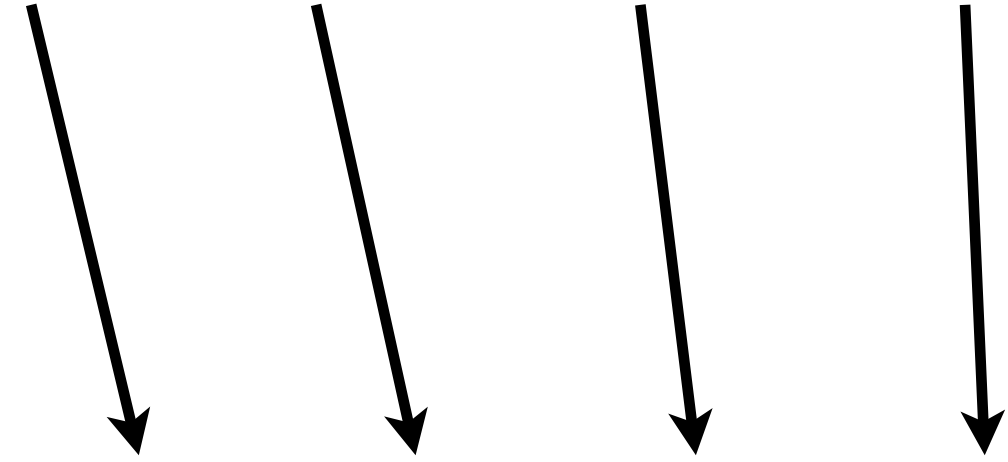
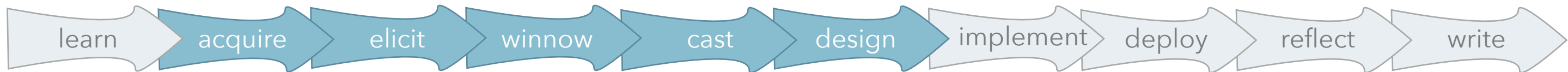

Original DSM framework

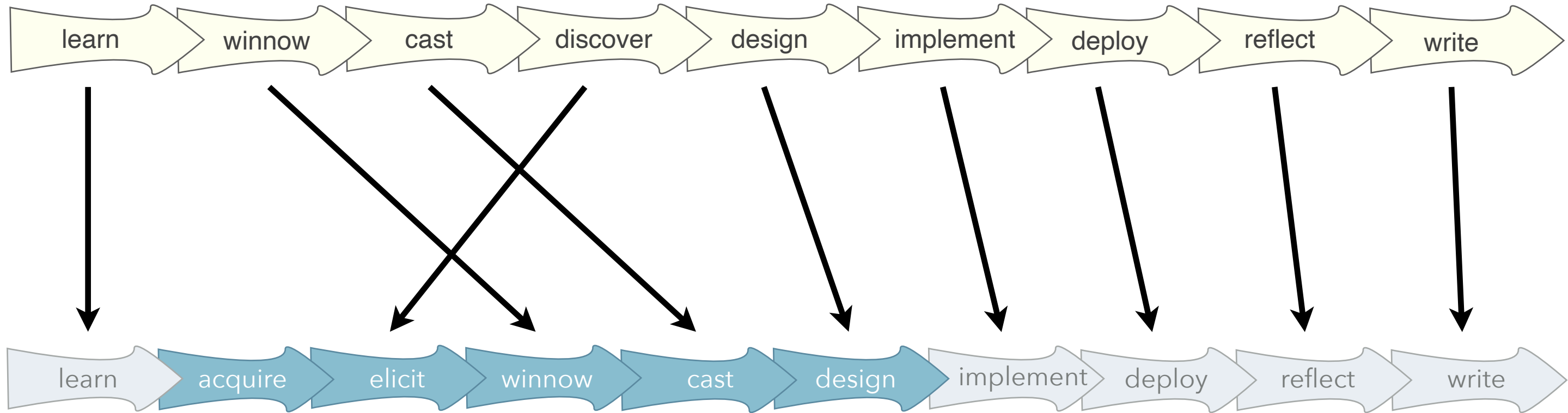

Data-first DSM framework

Three case studies of problem-driven work

- e-commerce



- facilities management



- biology





Zipeng
Liu



Shing Hei
Zhan



Aggregated Dendrograms

for Visual Comparison Between Many Phylogenetic Trees

<http://www.cs.ubc.ca/labs/imager/tr/2019/adview>

Aggregated Dendrograms for Visual Comparison Between Many Phylogenetic Trees.

Liu, Zhan, Munzner. *IEEE Trans. Visualization and Computer Graphics (TVCG)* 26(9):2732-2747, 2019.

Phylogenetic tree

Evolutionary relationships of organisms

Human	A	T	G	G	A	C	A
Chimpanzee	A	T	G	G	A	C	A
Macaque	A	C	G	G	A	C	A

Genetic information

Computational workflow

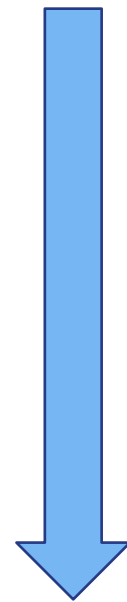

Phylogenetic tree

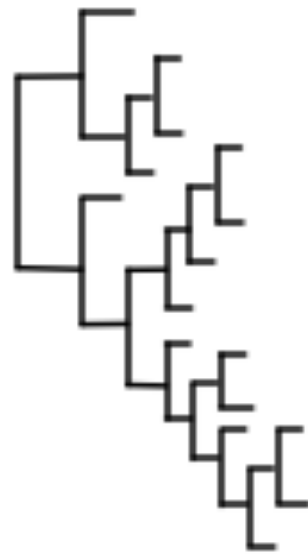

Many phylogenetic trees

Human
Chimpanzee
Macaque

A	T	G	G	A	C	A
A	T	G	G	A	C	A
A	C	G	G	A	C	A

Genetic information

Computational workflow

Phylogenetic tree

- Understand relationships between genes and species trees
- Explore trees generated with different methods and data

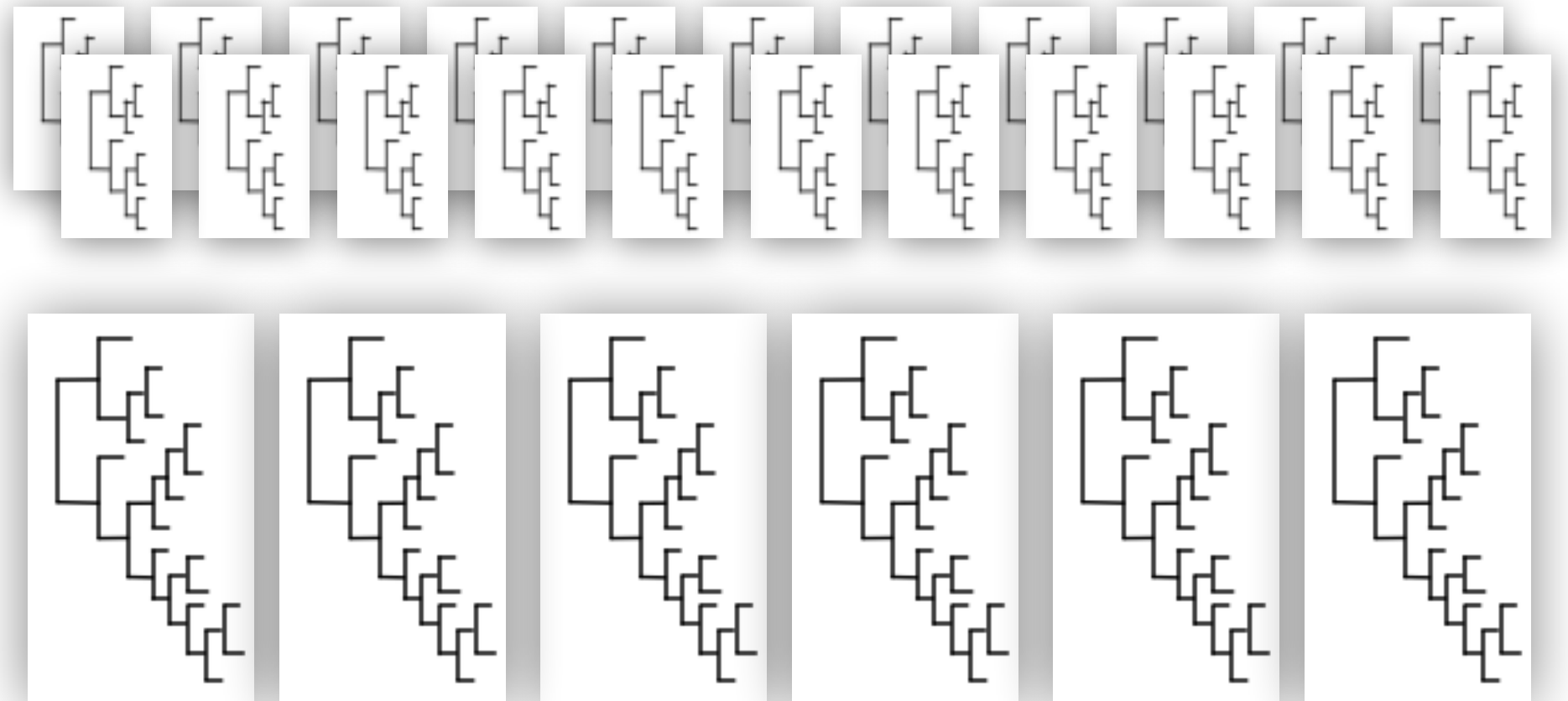

Scalability of Existing Tree Comparison Systems

#Trees: how many trees to compare



Level of detail (LoD):
how much details are visible

Scalability of Existing Tree Comparison Systems

#Trees: how many trees to compare

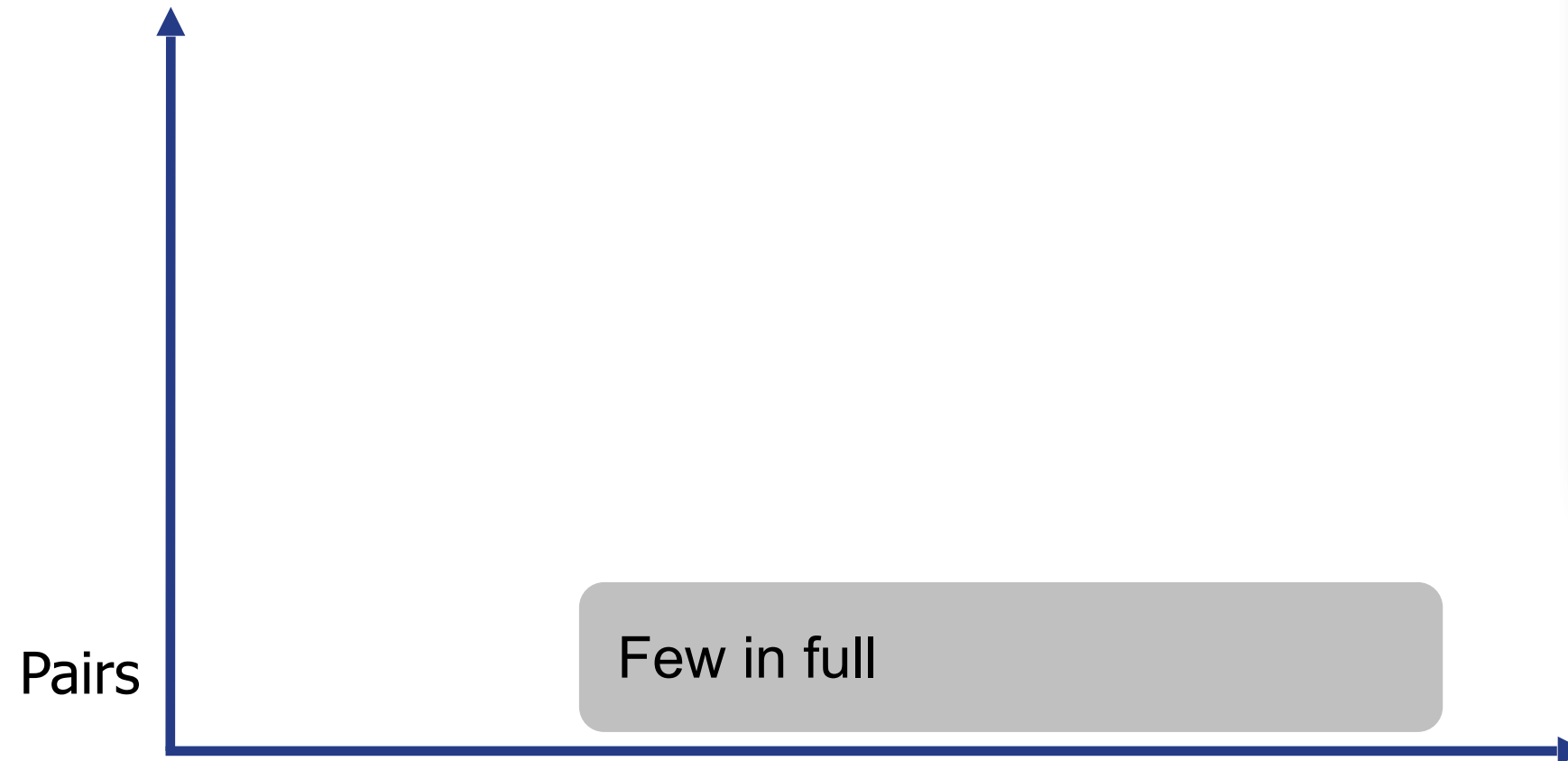

Simplified structure

Full topology

Level of detail (LoD):
how much details are visible

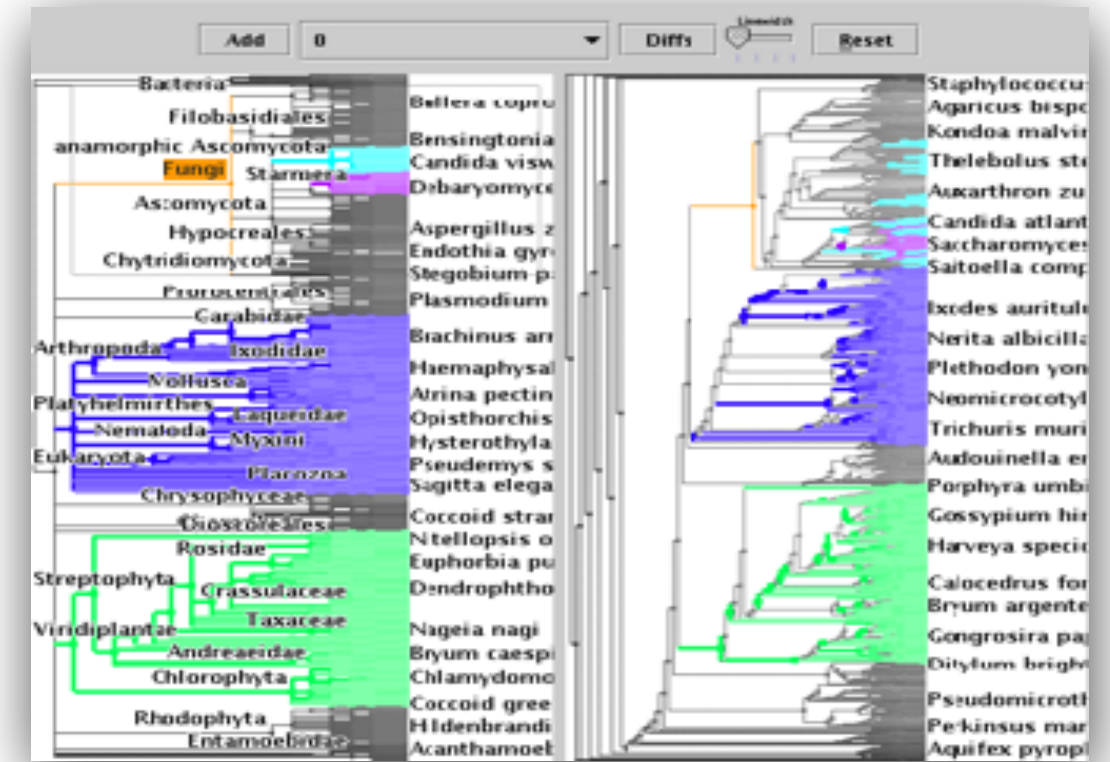

TreeJuxtaposer.

Munzner, Guimbretière, Zhang, Zhou.
SIGGRAPH 2003

Scalability of Existing Tree Comparison Systems

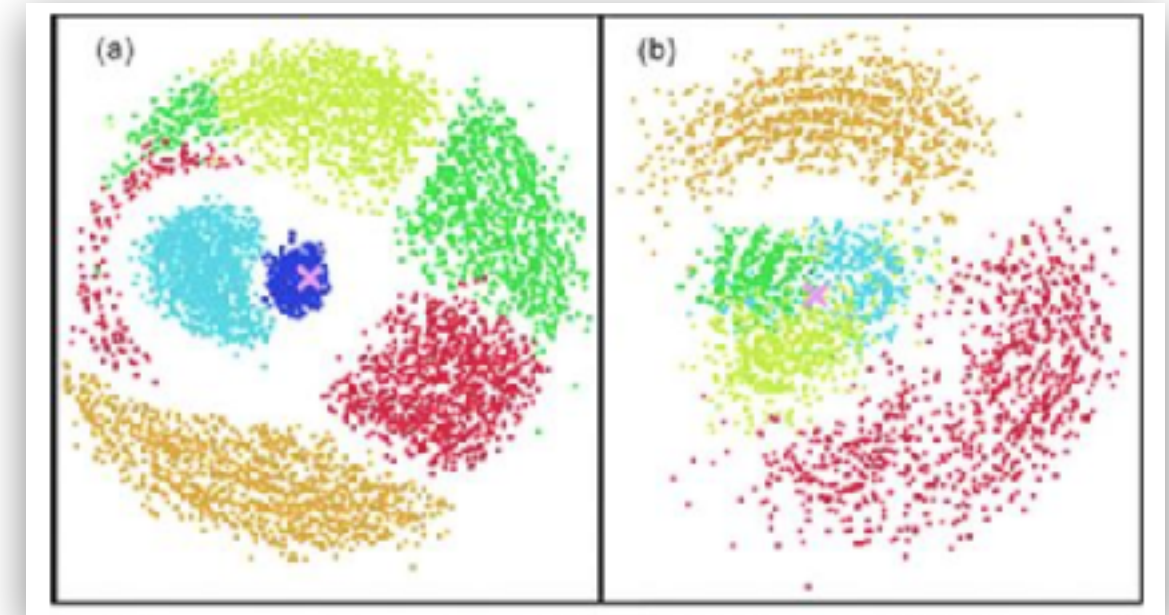
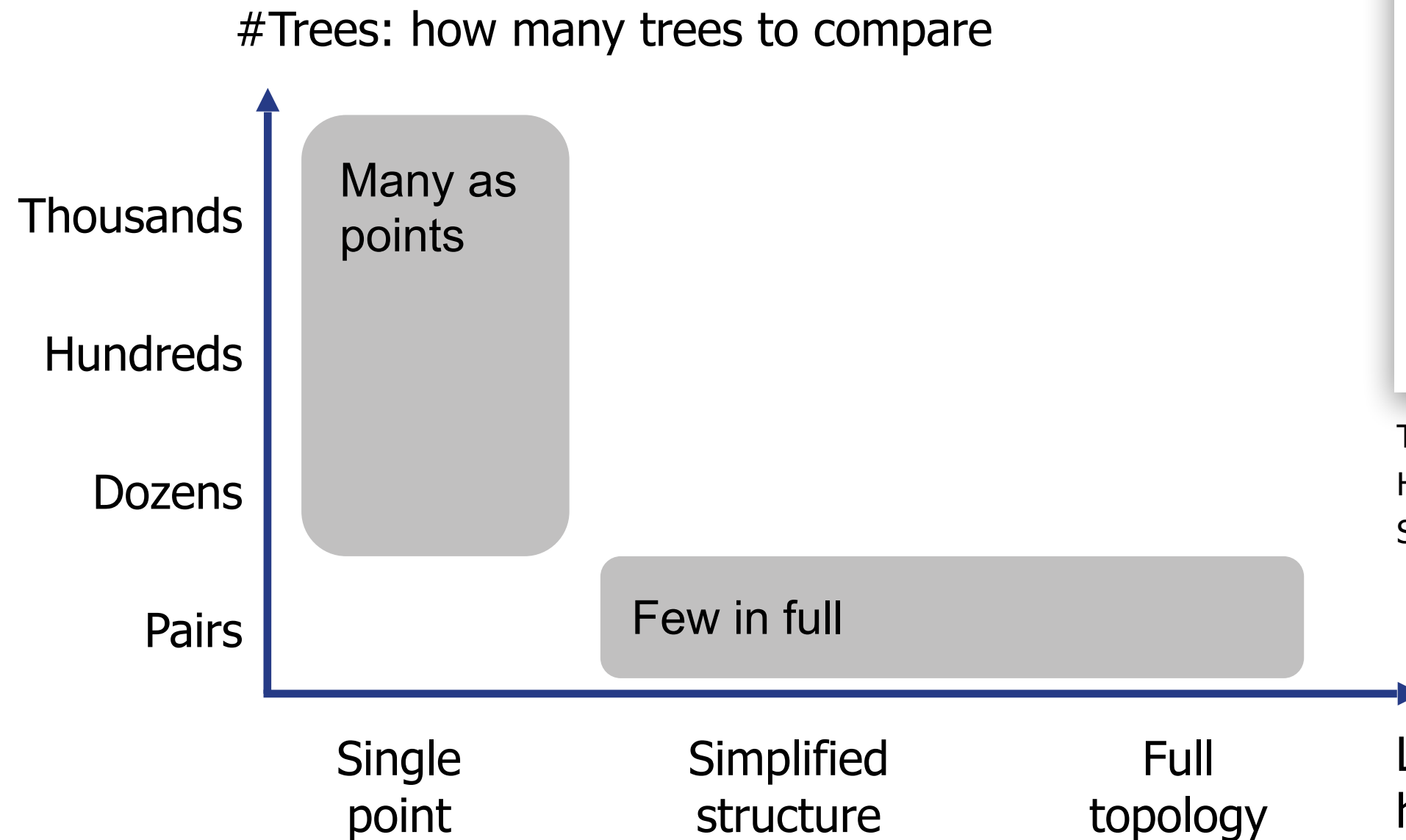

Tree space.
Hillis, Heath, John.
Systematic Biology 2005.

Scalability of Existing Tree Comparison Systems

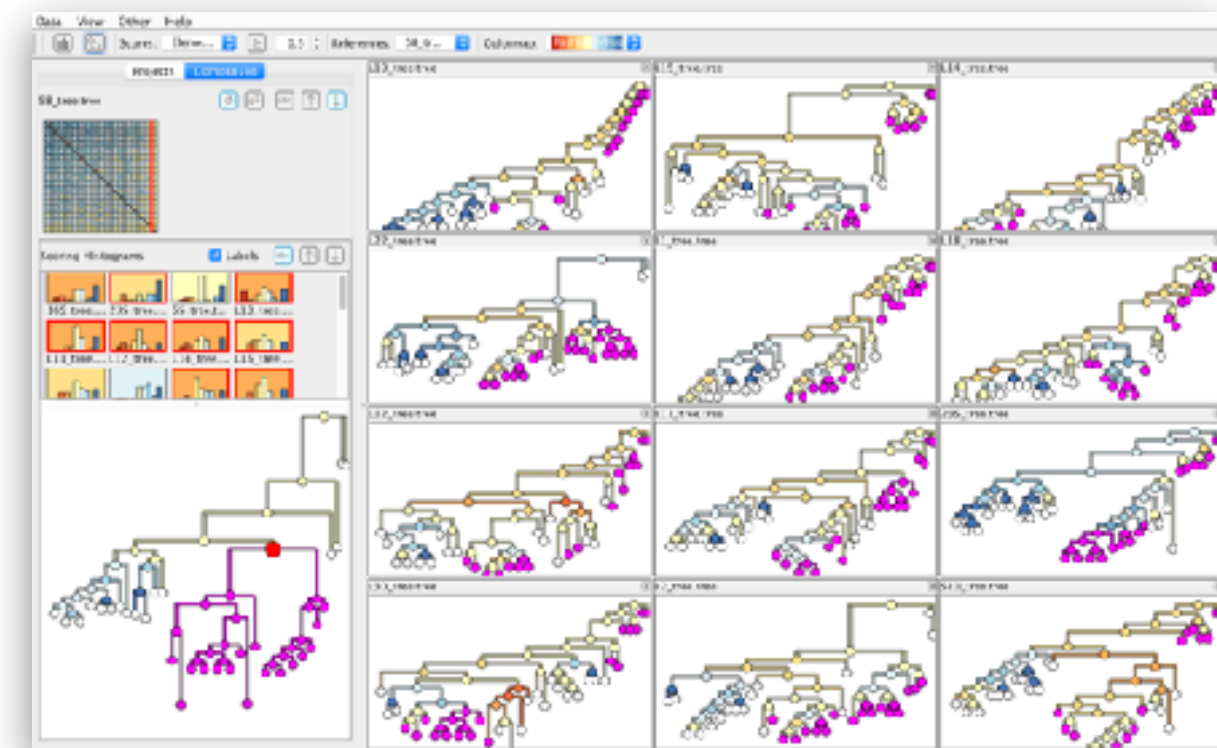
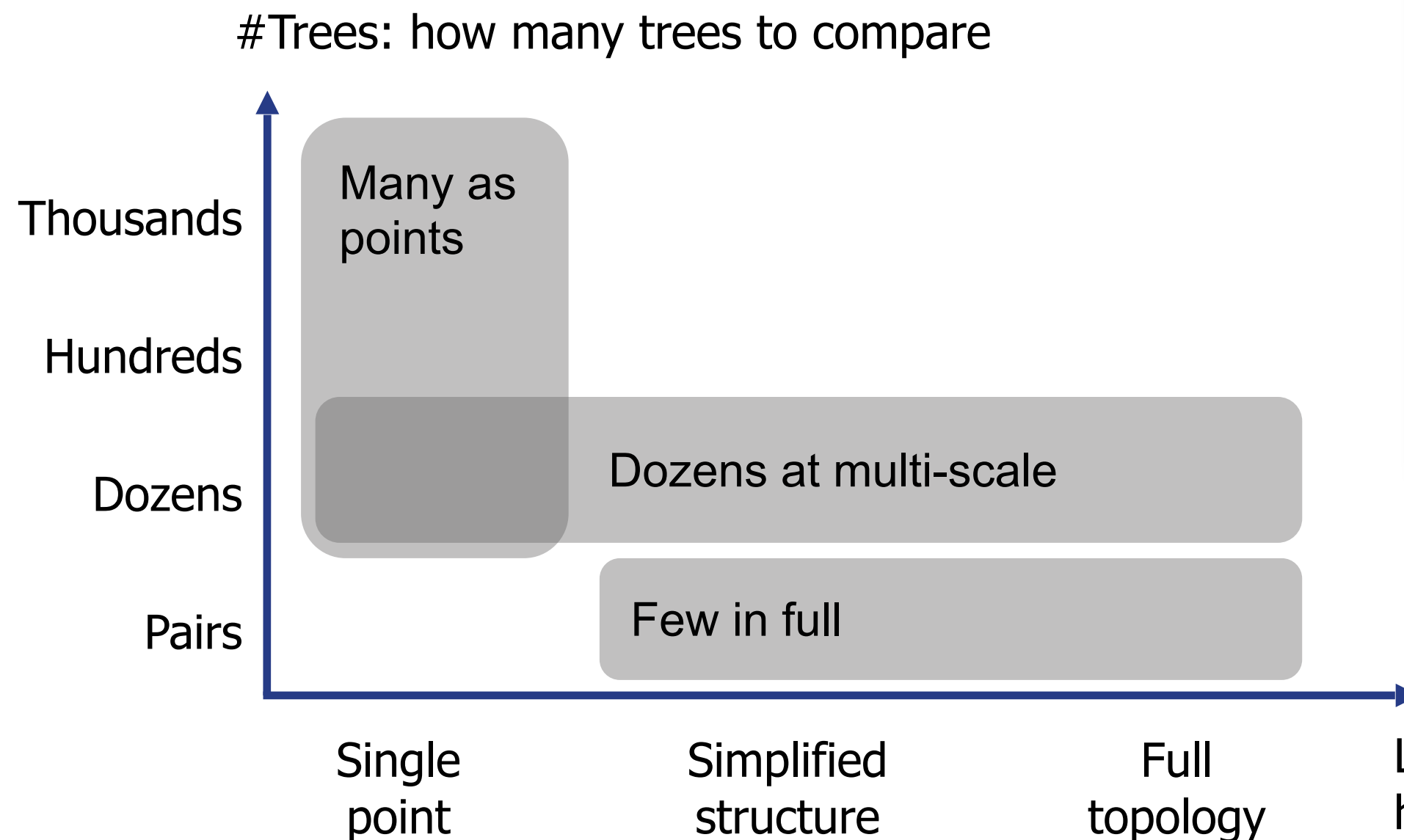

Interactive visual comparison of multiple trees.
Bremm, Landesberger, Heß, Schreck, Weil, Hamacher.
VAST 2011.

Comparing many phylogenetic trees

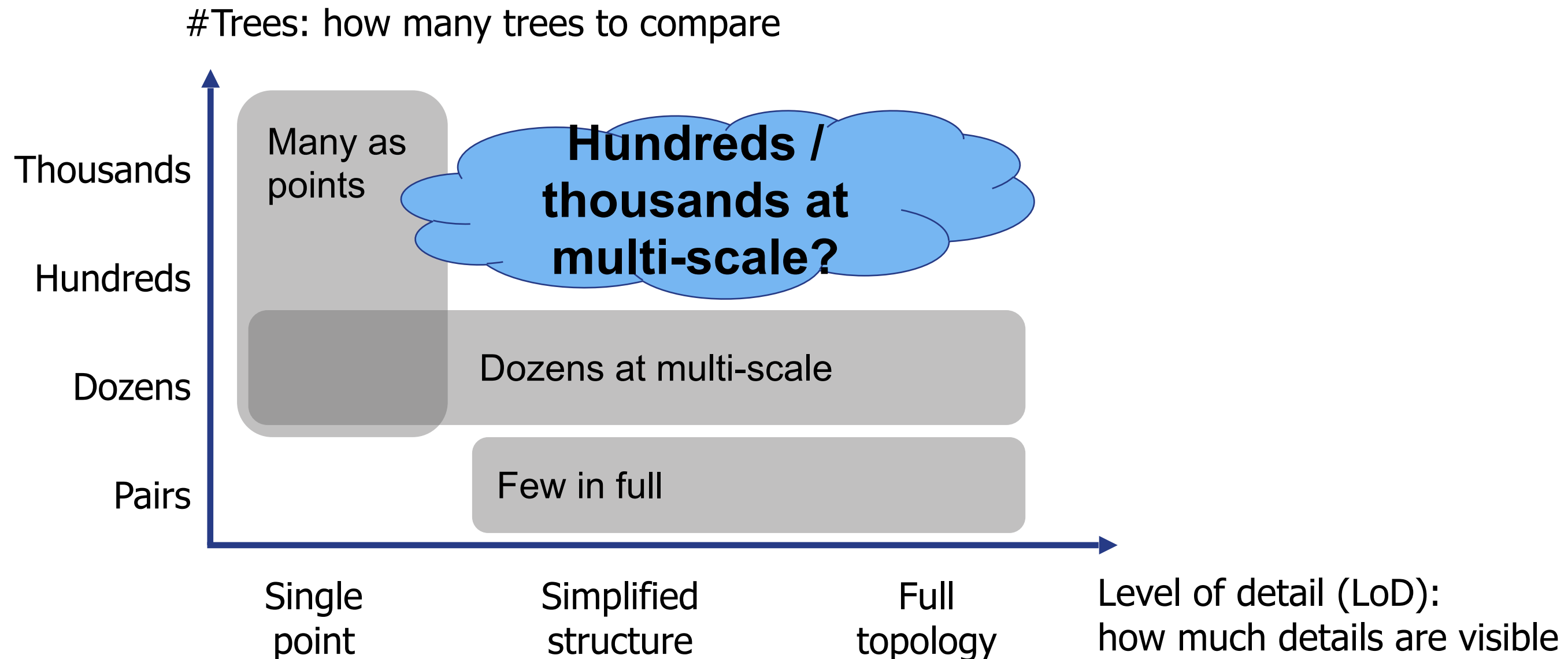

Contributions include idiom & algorithm levels

- Data and task abstractions for comparison of phylogenetic trees

Contributions include idiom & algorithm levels

- Data and task abstractions for comparison of phylogenetic trees
- A new visual encoding: **Aggregated Dendrogram**
 - Compact tree representation that focuses on selected subtrees
 - Adapts to available screen space

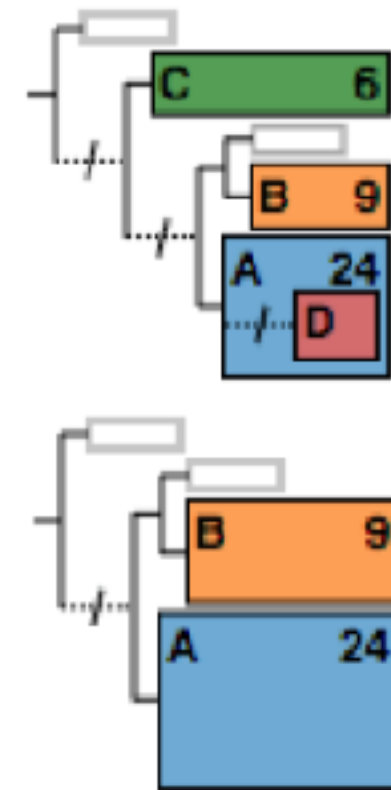

Contributions include idiom & algorithm levels

- Data and task abstractions for comparison of phylogenetic trees
- A new visual encoding: **Aggregated Dendrogram**
 - Compact tree representation that focuses on selected subtrees
 - Adapts to available screen space
- A multi-view interactive tool: **ADView**
 - Covers multiple levels of details for tree comparison

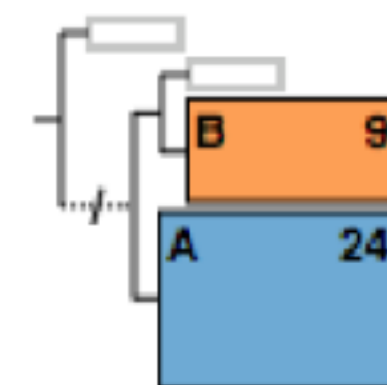
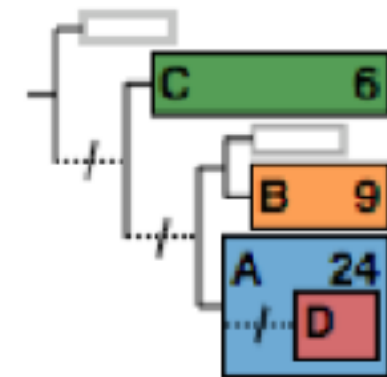



Data & Tasks

- Tree data
- Two crucial tasks

Tree data

Reference tree

vs.

Tree collection

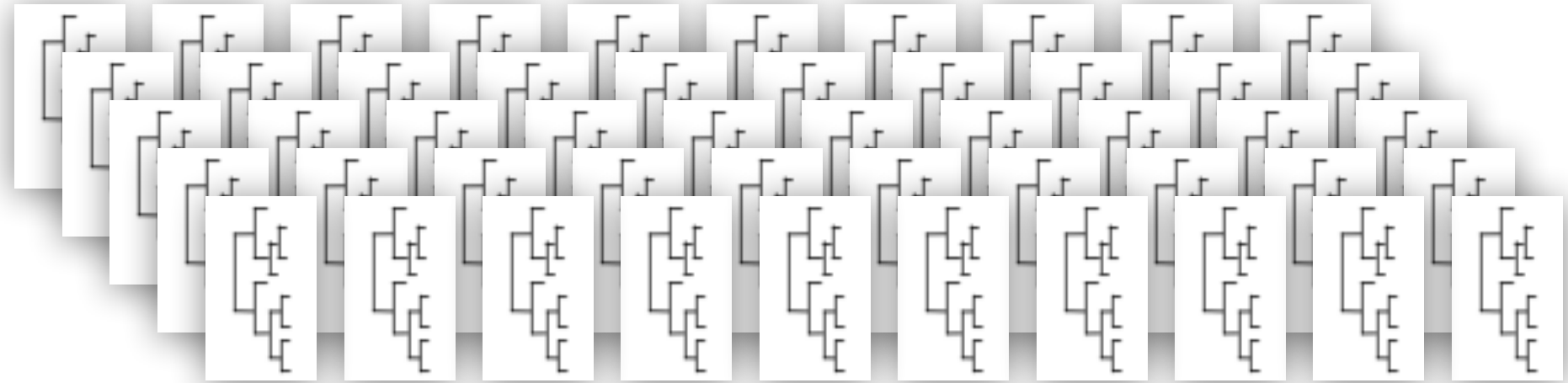
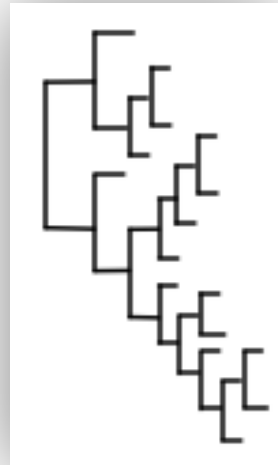

Two crucial tasks

Topological relationships between subtrees / leaf nodes

Two crucial tasks

Topological relationships between subtrees / leaf nodes

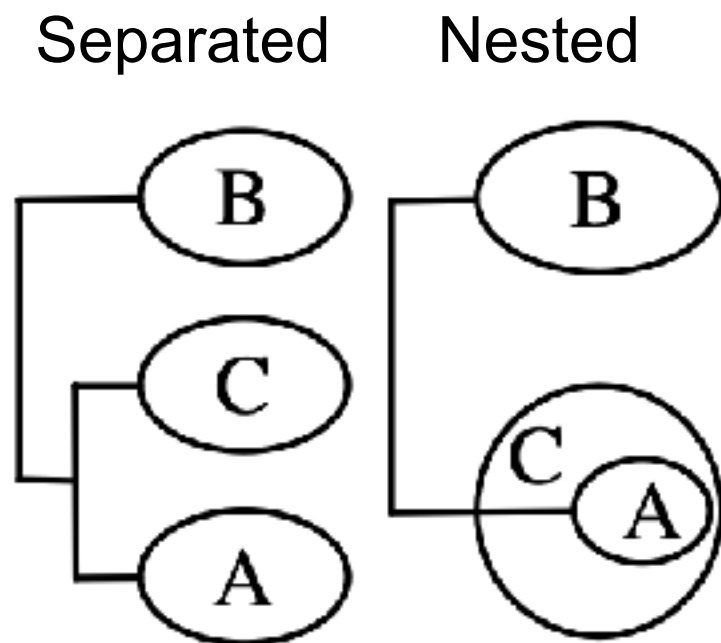

Two crucial tasks

Topological relationships between subtrees / leaf nodes

- Topological distance

Leaf node memberships compared to reference tree

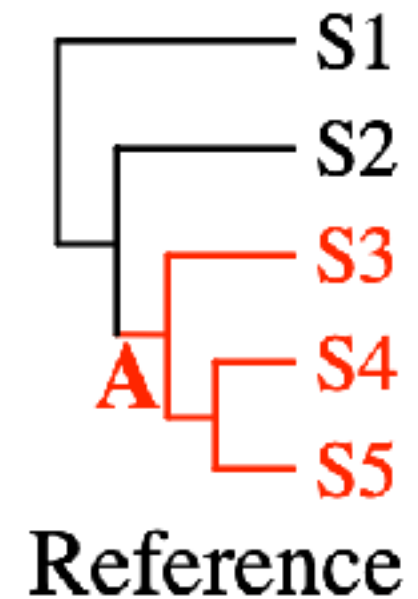
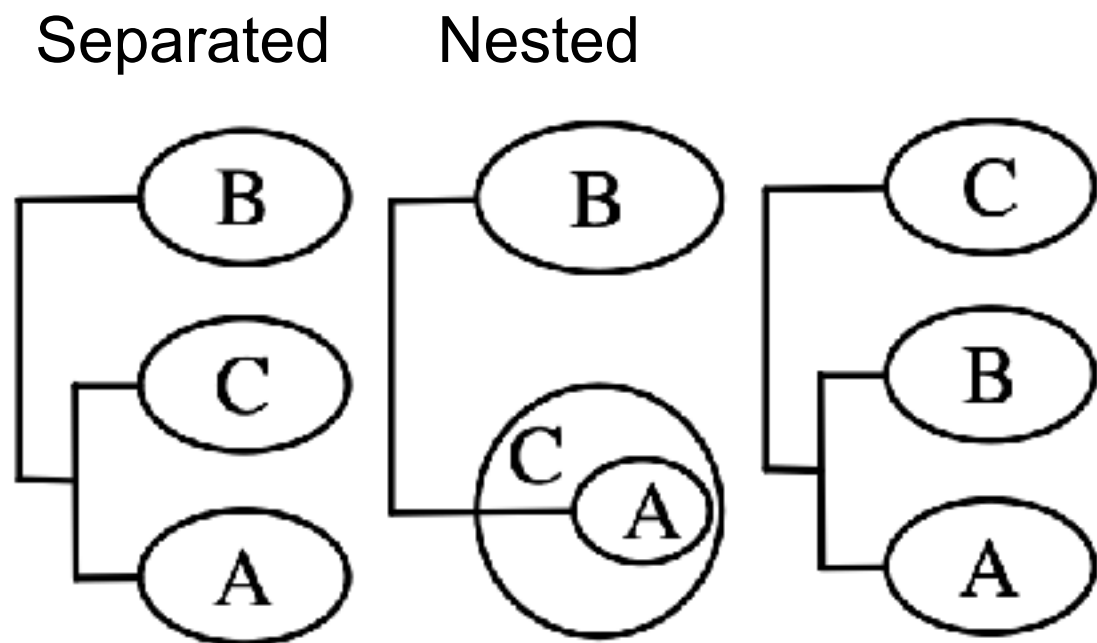

Two crucial tasks

Topological relationships between subtrees / leaf nodes

- Topological distance

Leaf node memberships compared to reference tree

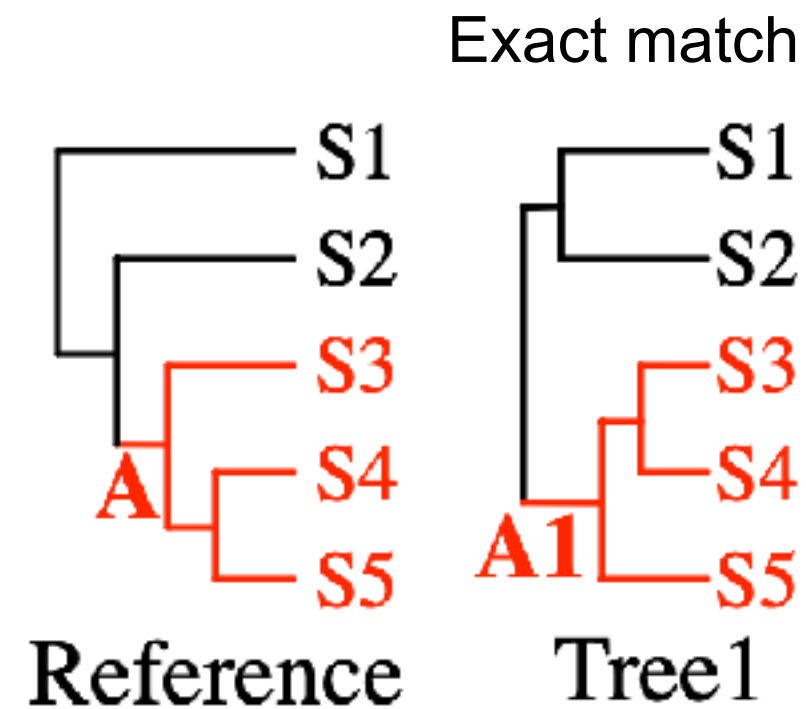
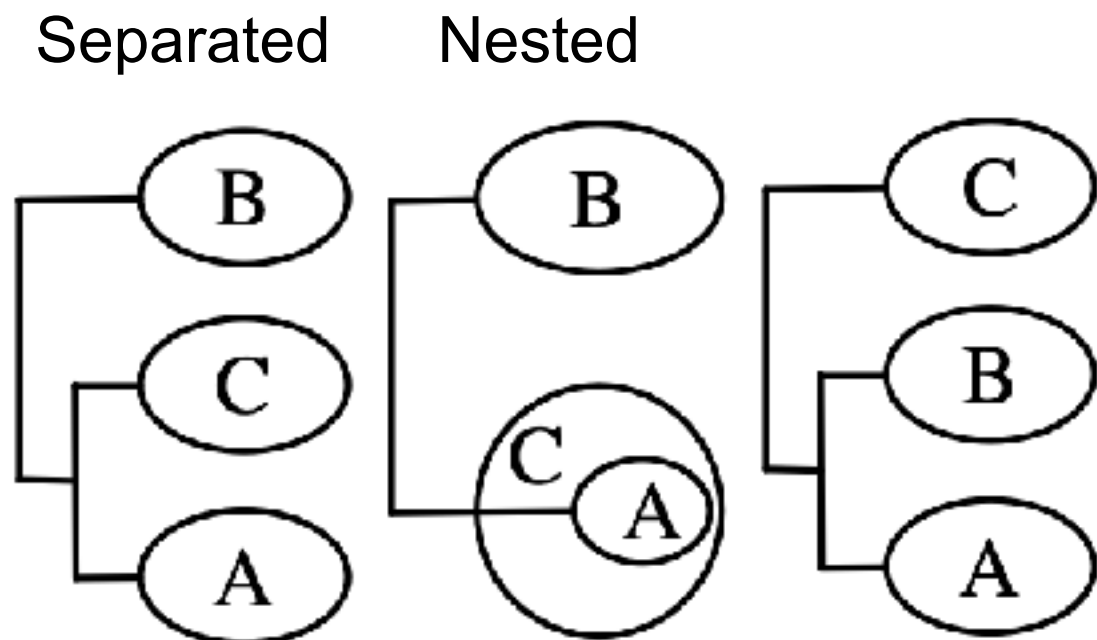

Two crucial tasks

Topological relationships between subtrees / leaf nodes

- Topological distance

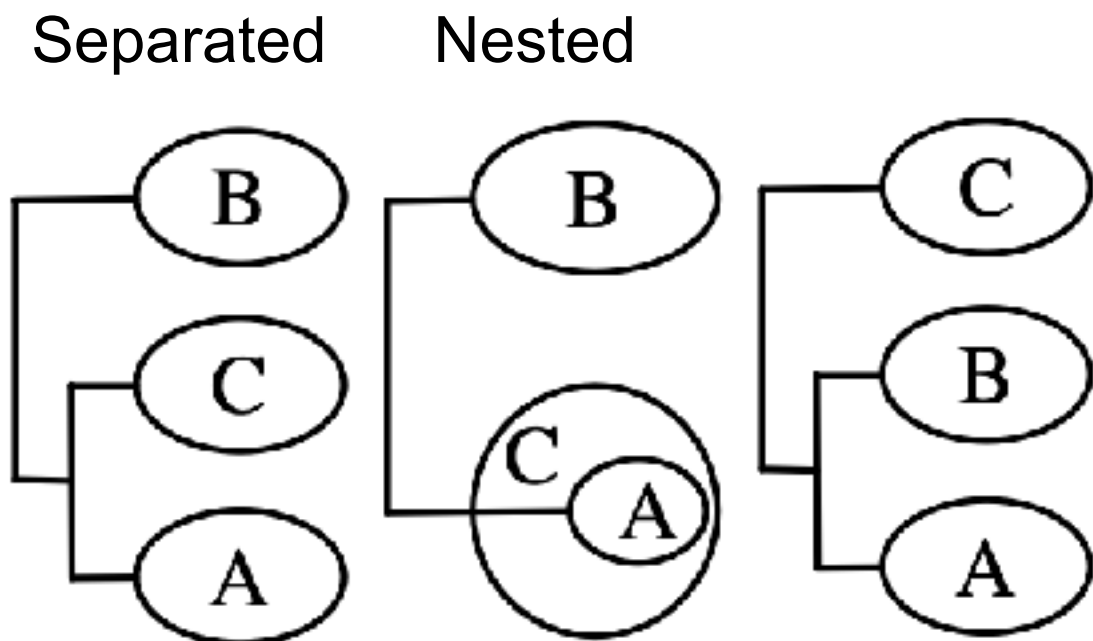

Leaf node memberships compared to reference tree

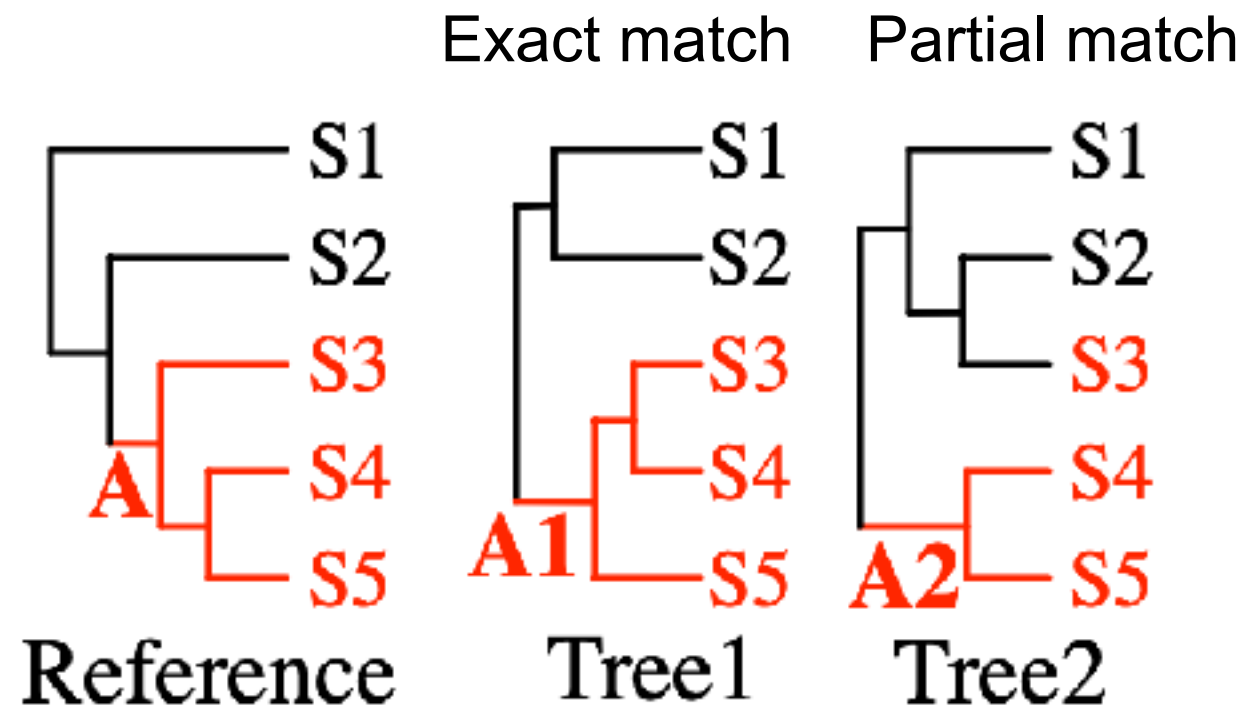



Aggregated Dendrogram (AD)

- Intuition
- Visual design

Intuition

Use glyphs to compress a tree according to user selections

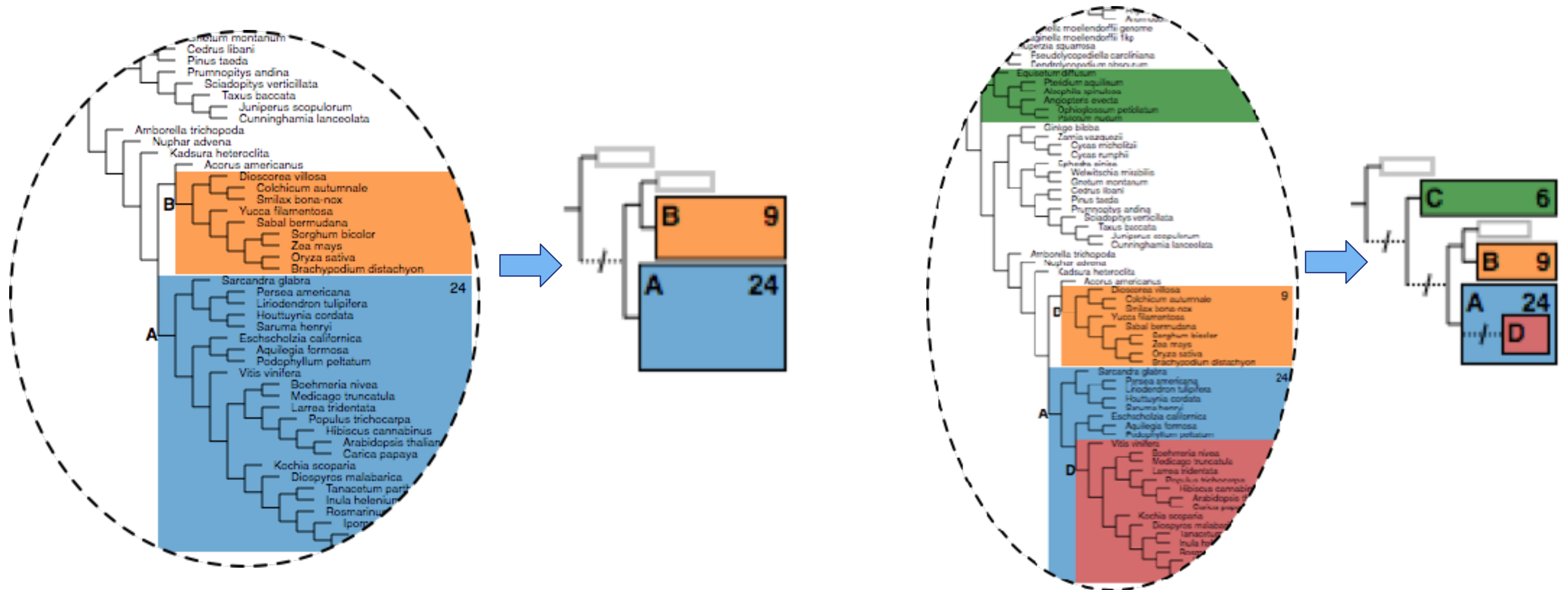

Visual design: focus + context

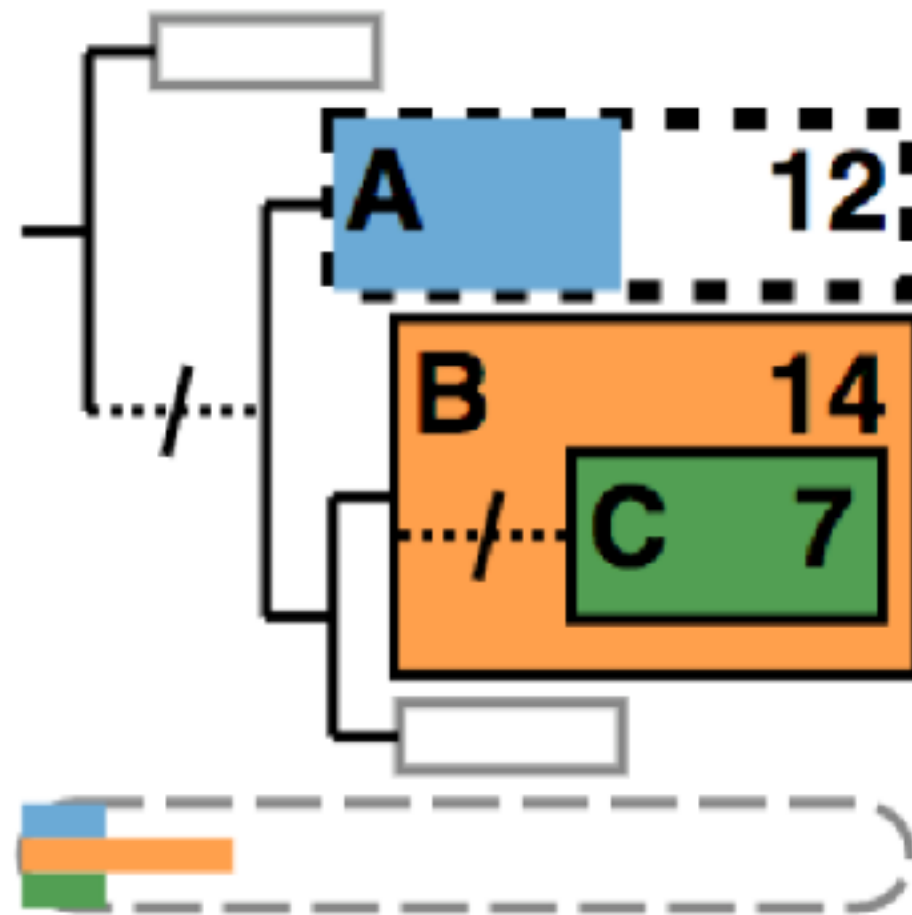

Visual design: focus + context

- Focus
 - Selected subtrees

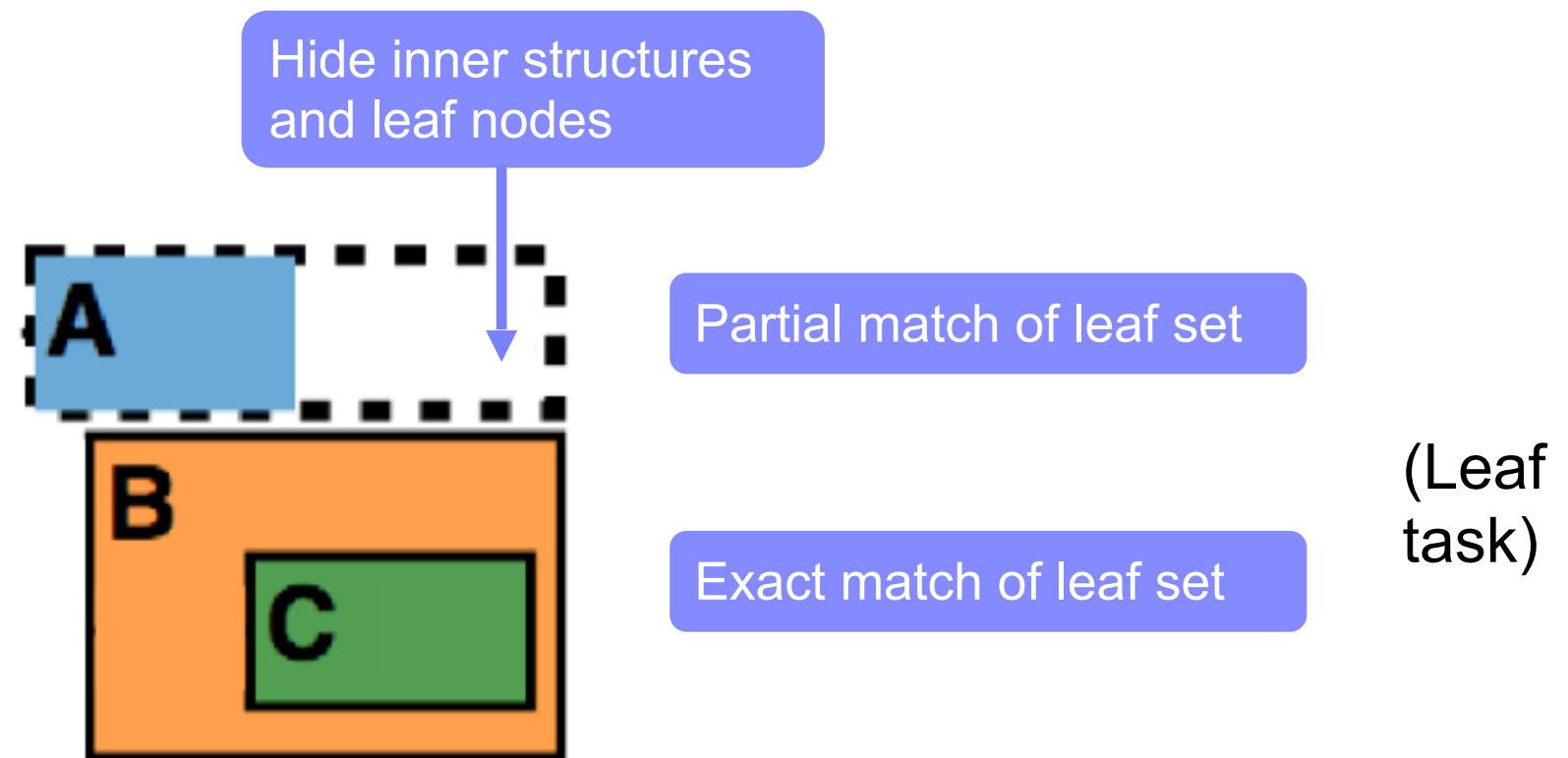

Visual design: focus + context

- Focus
 - Selected subtrees

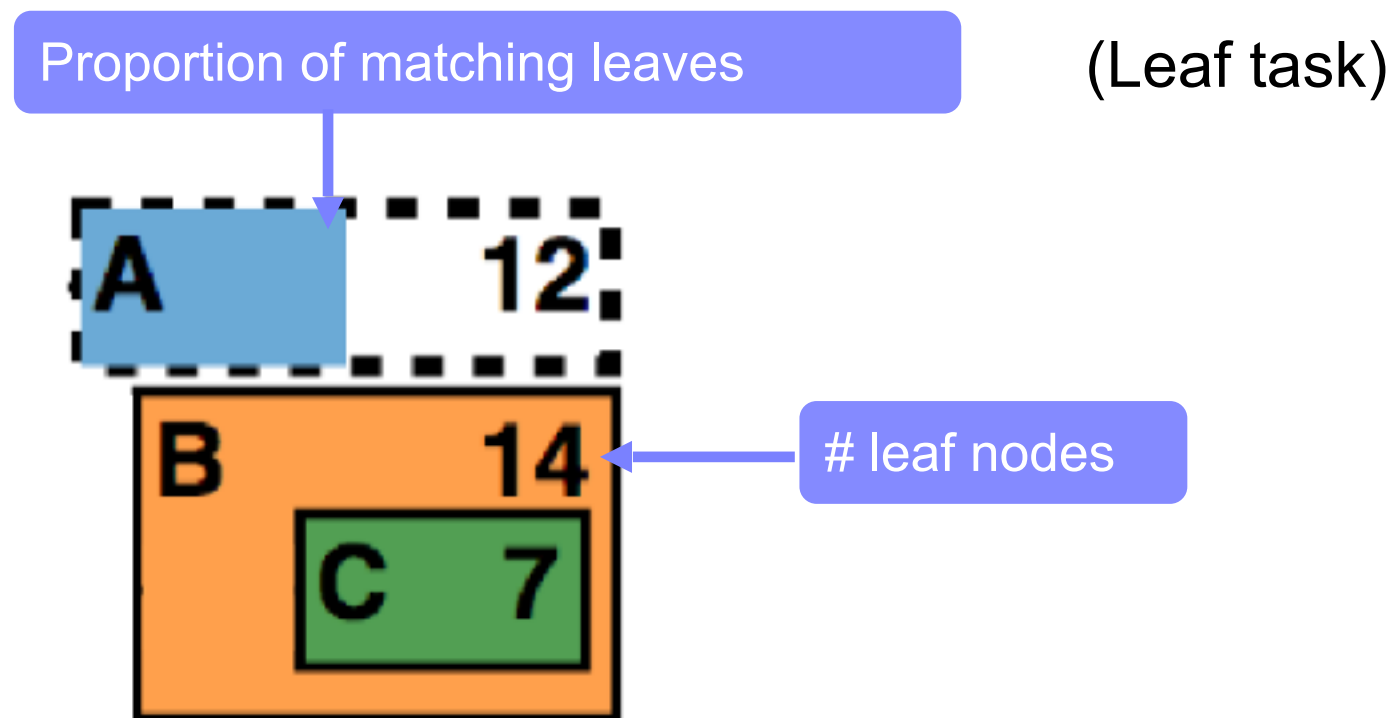

Visual design: focus + context

- Focus
 - Selected subtrees
 - Topological relationships between them

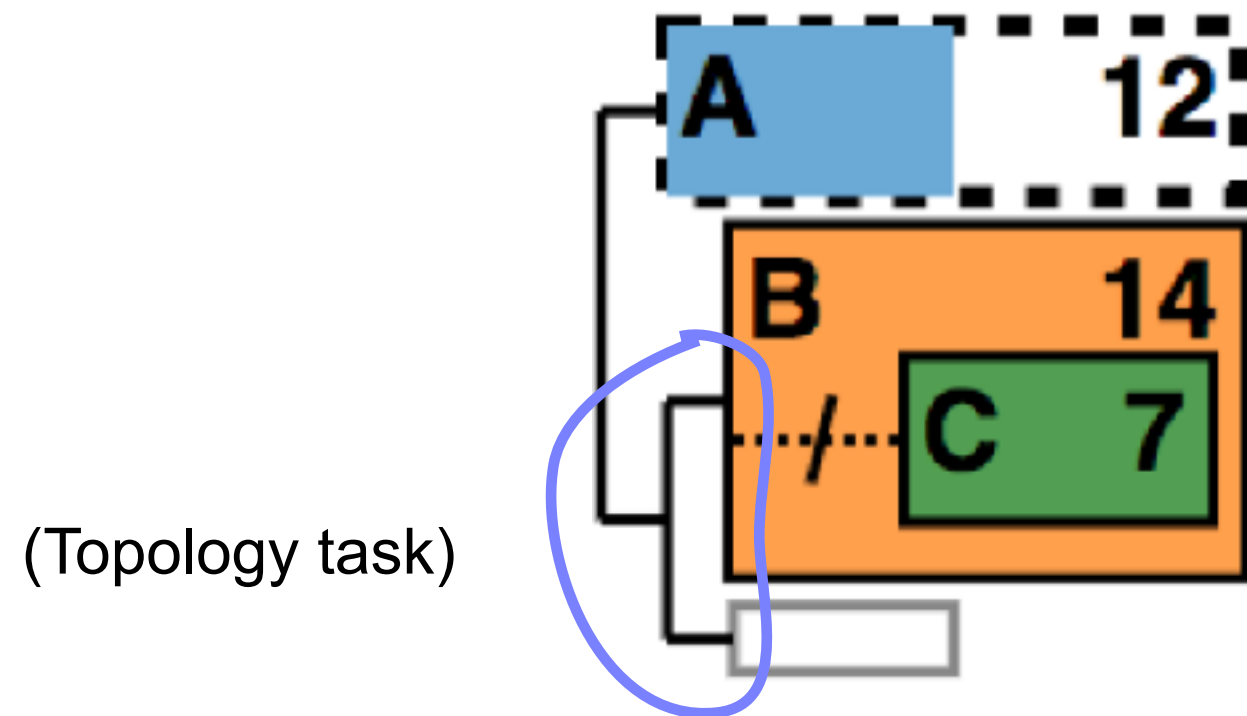

Visual design: focus + context

- Focus
 - Selected subtrees
 - Topological relationships between them

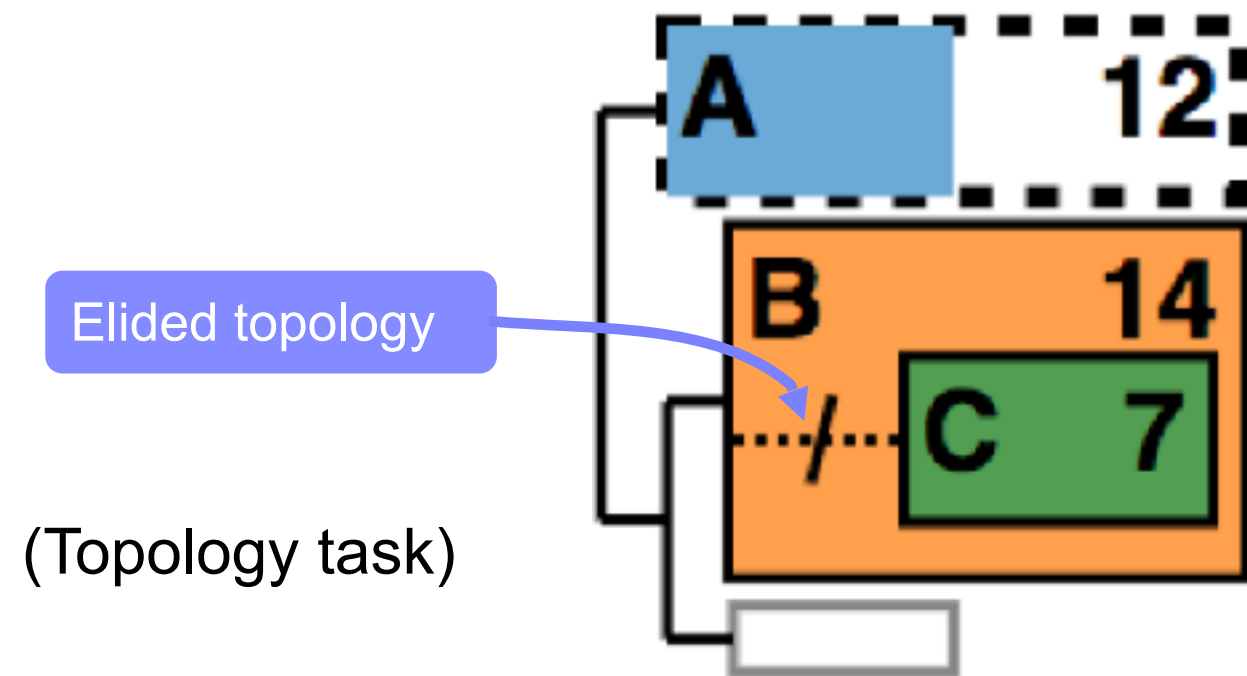

Visual design: focus + context

- Focus
 - Selected subtrees
 - Topological relationships between them
- Context
 - Neighboring subtrees

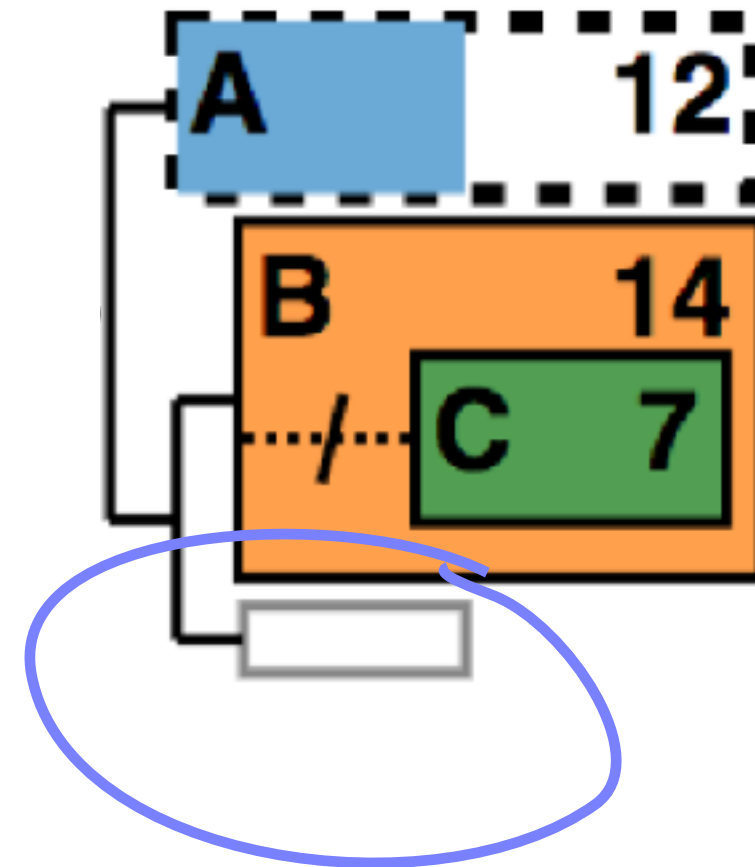

Visual design: focus + context

- Focus
 - Selected subtrees
 - Topological relationships between them
- Context
 - Neighboring subtrees
 - Upstream topology and root

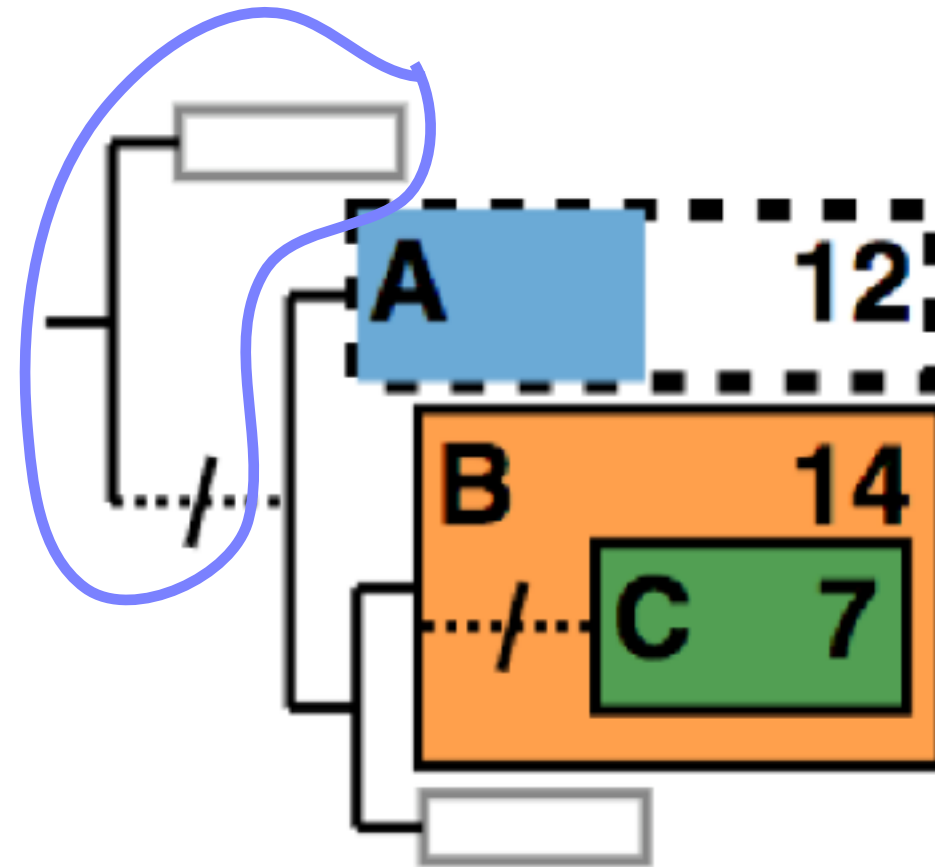

Visual design: focus + context

- Focus
 - Selected subtrees
 - Topological relationships between them
- Context
 - Neighboring subtrees
 - Upstream topology and root
 - Missing leaf nodes

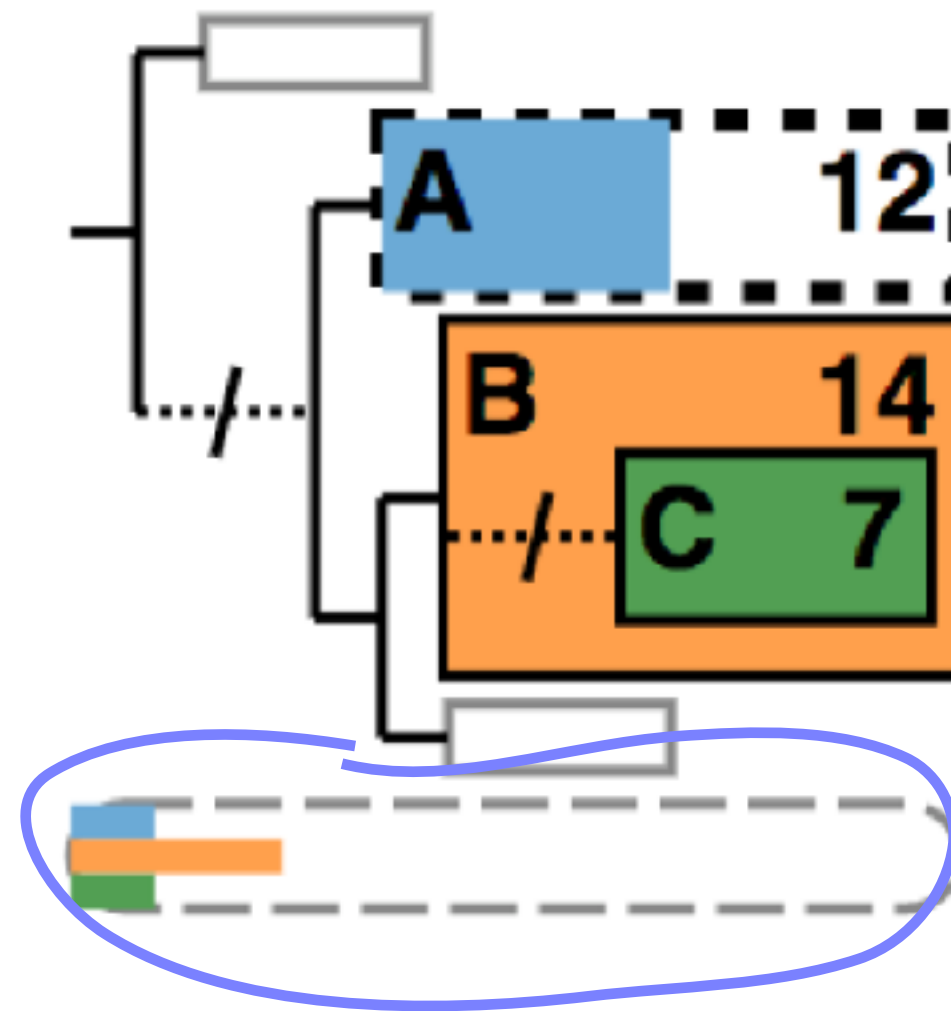

Visual design: algorithm adapts to space

- Show more info when space permitted
 - Labels
 - #leaf nodes
 - Neighboring blocks

40x40 px



80x80 px

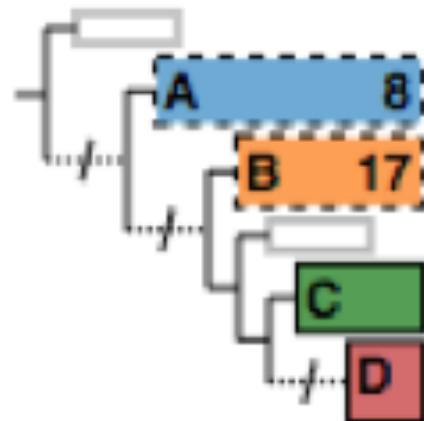

160x160 px

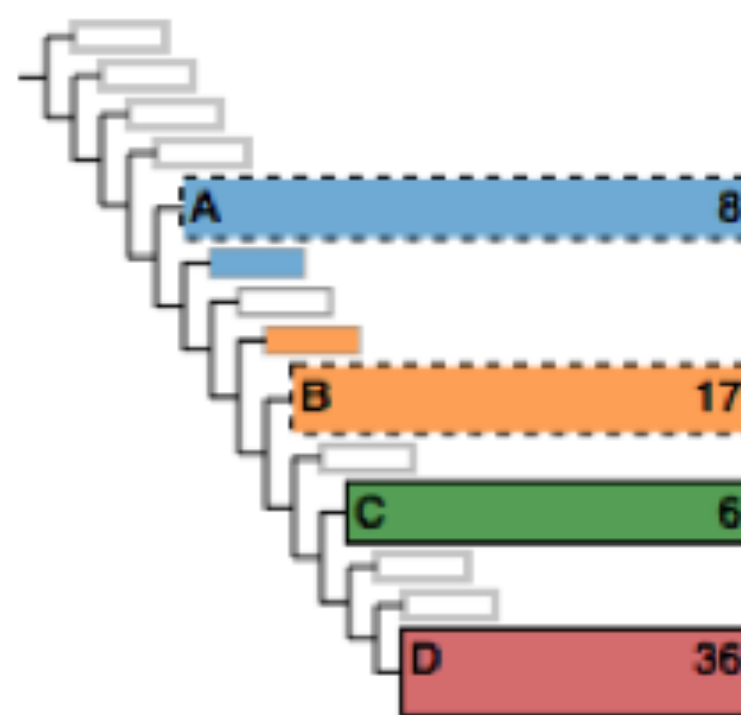

ADView Interface: Multi-level structure across views

The screenshot displays the ADView interface, which is used for visualizing and analyzing phylogenetic tree collections. The interface is organized into several main sections:

- Reference Tree:** Located on the left, it shows a large phylogenetic tree with a color-coded background. Above it are two histograms: "Dist. support (0.21 - 0.4)" and "Dist. Exact match (0.07) 34".
- Tree Collection:** The central area, titled "Tree Collection", contains a "Tree Distribution by Reference Partition" table and a "Tree List" on the right. The table shows the distribution of trees across four partitions (A, B, C, D). The "Tree List" on the right shows a list of tree identifiers with checkboxes for selection.
- Aggregated Dendrograms (AD):** This section displays a grid of small dendrograms representing the aggregated structure. It includes controls for "manual size", "width", "height", "max. font size", "show labels", and "show colors". There are also checkboxes for "Clusters" and "Individuals".
- Tree Similarity:** Located on the right side, it features a "Distance" dropdown (set to "full") and a scatter plot showing the similarity between trees.
- Corresponding Br. Attr.:** This section provides additional analysis, including "Dist. support" and "Dist. similarity" histograms, and checkboxes for "activate range selection".

At the bottom of the interface, there is a legend for "Block" (context, exact matched, head matched, missing tax) and "Tree" (always label, bounding box hovered, selected). The bottom right corner shows the dataset name "1KP plant 69 Species" and a "Logout" button.

Multi-level structure across views

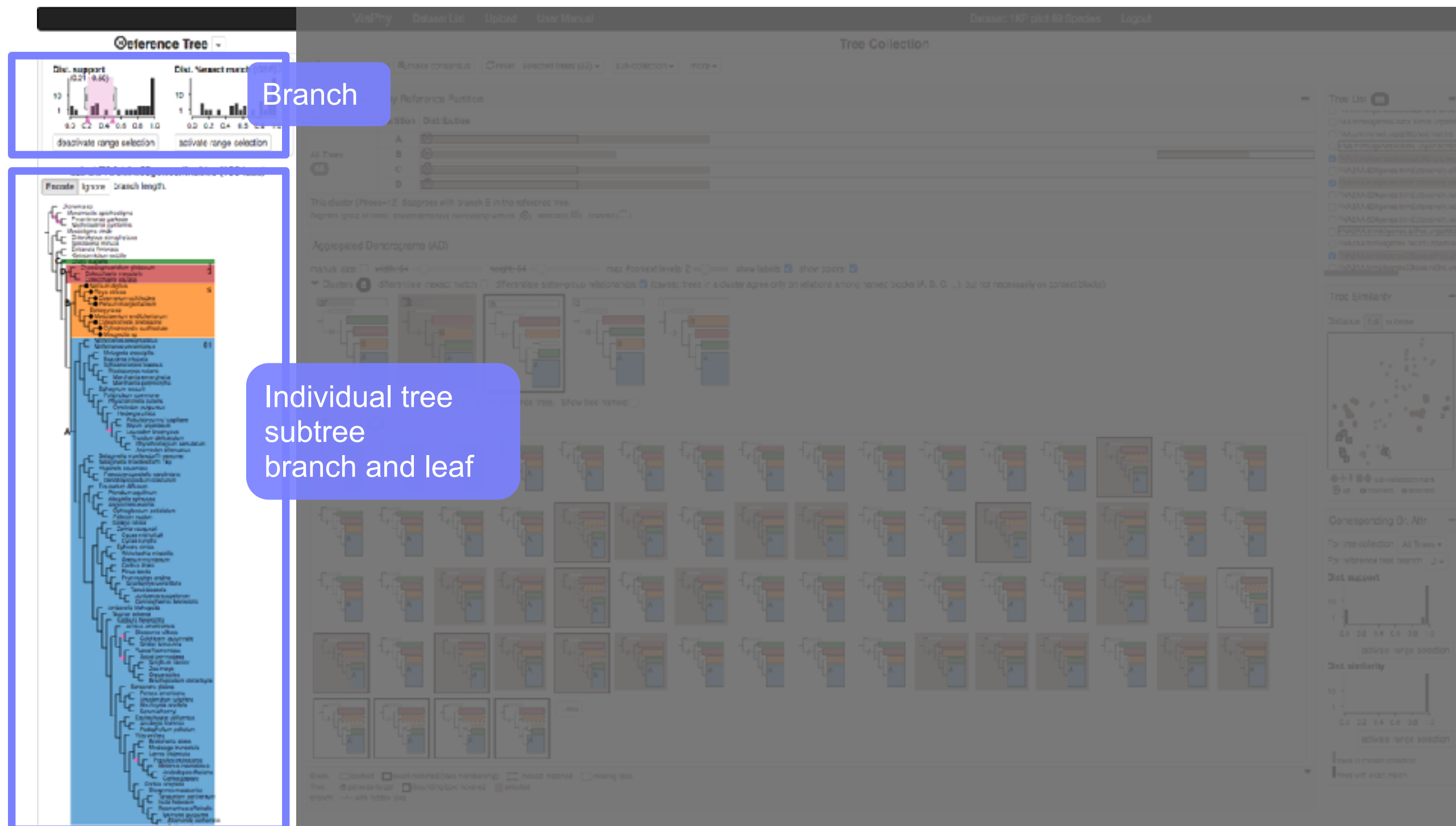

Interface walkthrough: tree collection main views

The screenshot displays the 'Tree Collection' interface with the following components:

- Top Navigation:** Includes 'VisPhy', 'Dataset List', 'Upload', 'User Manual', 'Dataset: 1KP pilot 69 Species', and 'Logout'.
- Tree Distribution by Reference Partition:** A table showing the distribution of trees across partitions A, B, C, and D. A callout 'Tree collection Subset of trees' points to this table.
- Annotations and Clusters:** A section for 'Annotations and Clusters (AD)' with various filters and a callout 'Tree collection Subset of trees'.
- All Trees Grid:** A grid of 66 small tree thumbnails. A callout 'Individual tree Subtree' points to one of these thumbnails.
- Reference Tree (Left Panel):** A large tree structure with associated support and similarity plots.
- Tree List (Right Panel):** A list of tree identifiers with checkboxes for selection.
- Tree Similarity (Right Panel):** A scatter plot showing the similarity between trees.
- Corresponding Br. Attr. (Right Panel):** Two plots showing distance support and distance similarity for a specific tree collection and reference branch.

Interface walkthrough: tree collection aux. views

The screenshot displays the 'Tree Collection' interface. On the left, a large reference tree is visible. The main area shows a grid of smaller trees. Three callout boxes are overlaid on the right side:

- Individual tree:** Points to a 'Tree List' panel on the right, which contains a list of tree identifiers with checkboxes.
- Tree collection:** Points to a scatter plot showing the relationship between different trees in the collection.
- branch:** Points to a 'Corresponding Br. Attr.' panel, which displays two histograms: 'Dist. support' and 'Dist. similarity', both with x-axes ranging from 0.0 to 1.0.

Validation with many biologists

- Work closely with a biology PhD student (second author)
- Demos, interviews and discussions
 - 10 biologists at different times throughout project

Validation with many biologists

- Work closely with a biology PhD student (second author)
- Demos, interviews and discussions
 - 10 biologists at different times throughout project
- User study sessions
 - 5 biologists
 - Using their own datasets

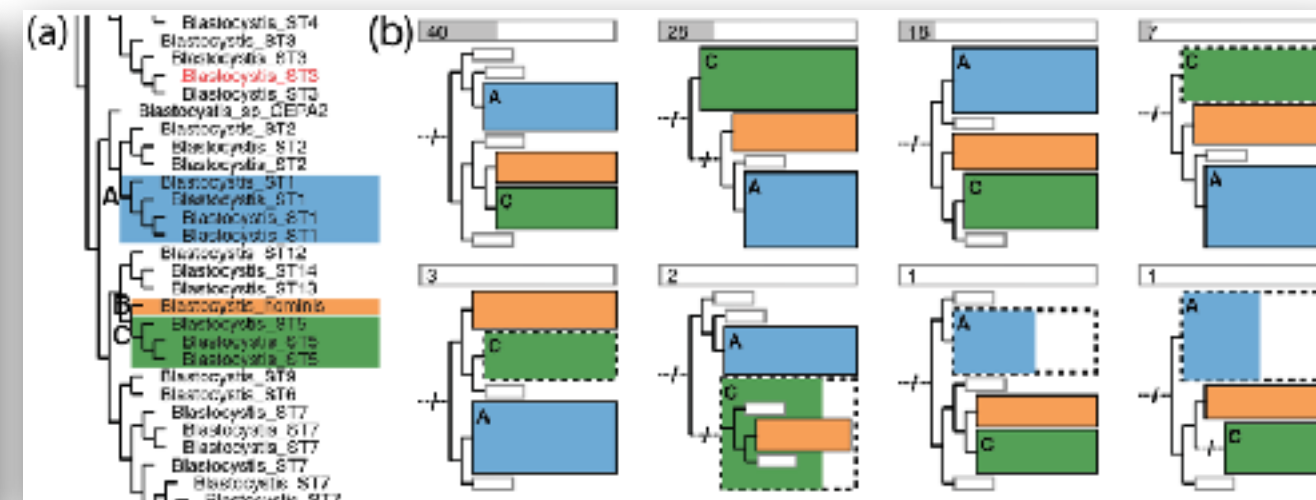
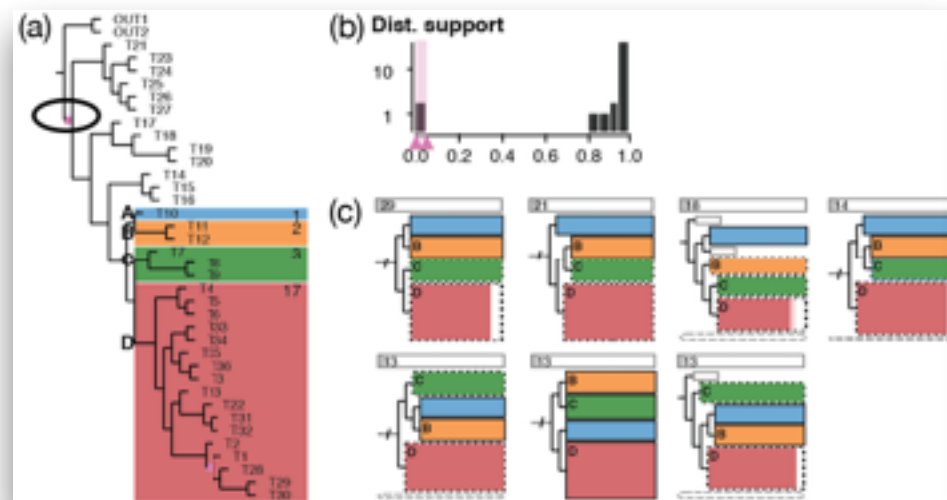
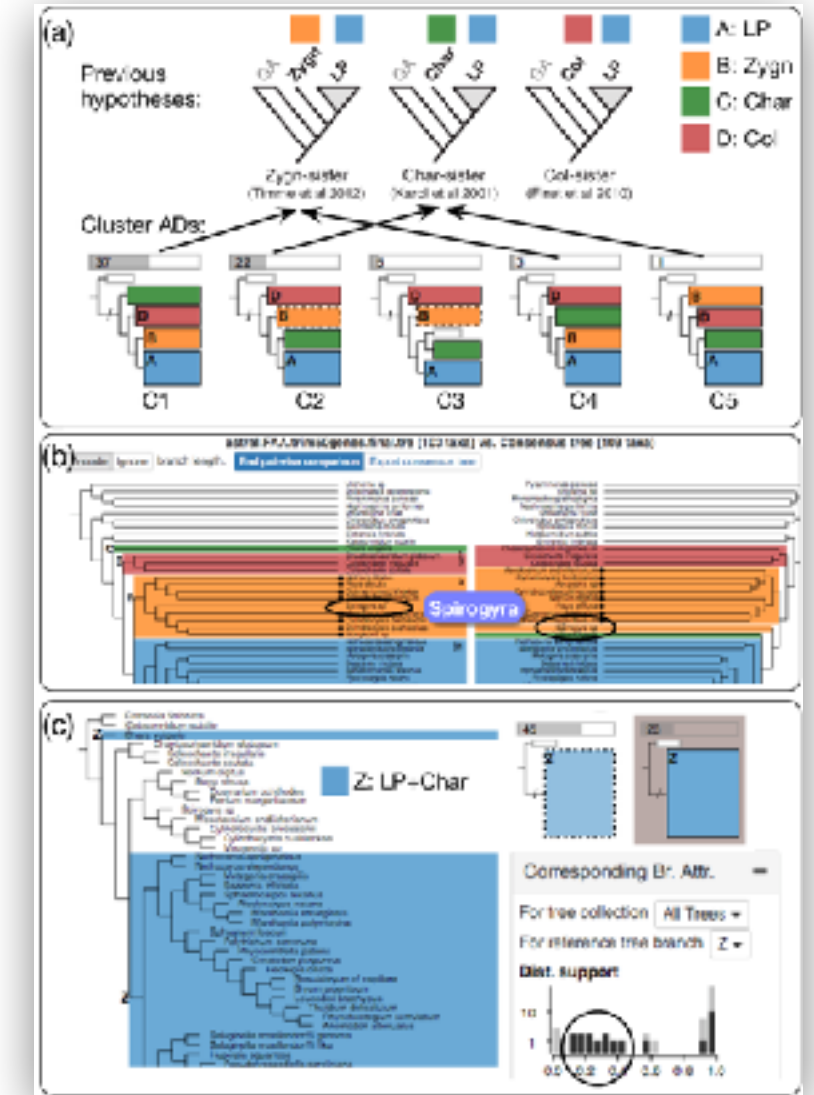

Validation with many biologists

- Work closely with a biology PhD student (second author)
- Demos, interviews and discussions
 - 10 biologists at different times throughout project
- User study sessions
 - 5 biologists
 - Using their own datasets
- Biologists confirmed
 - Validity of data and task abstractions
 - Utility of ADView

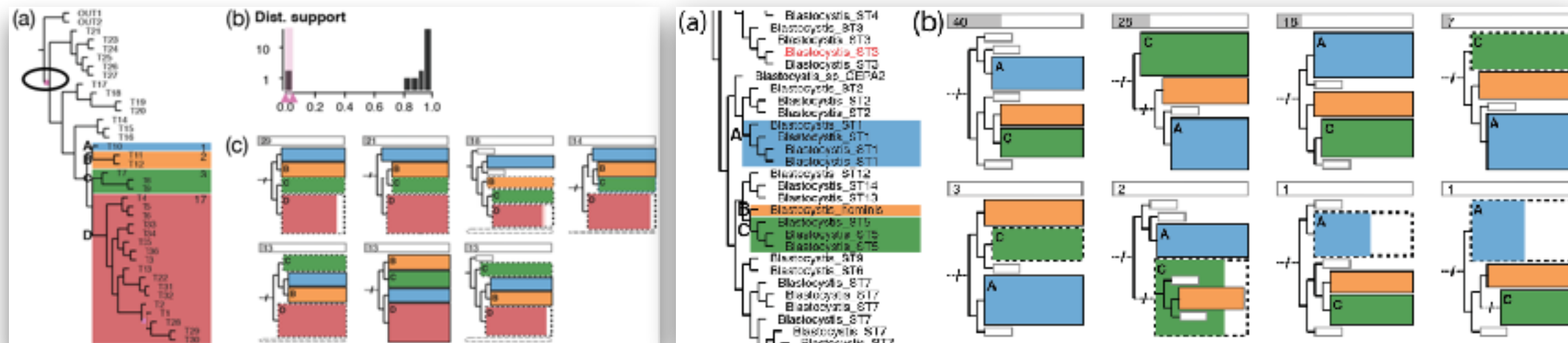
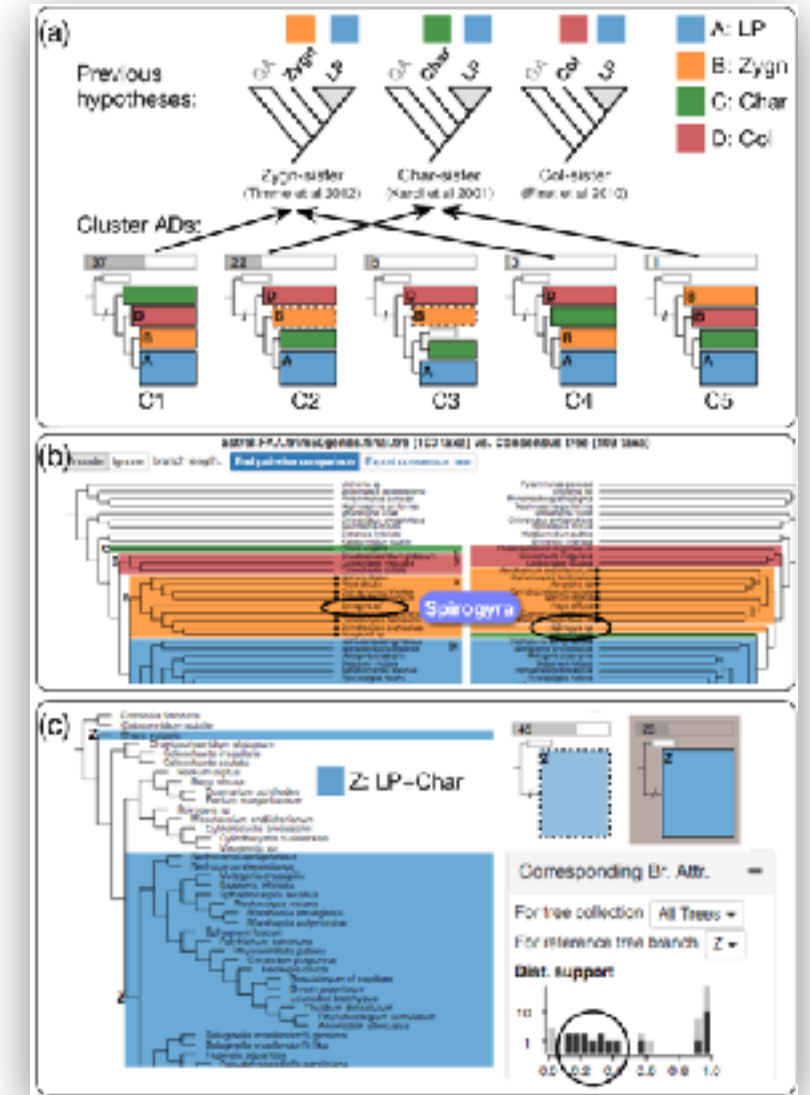

Problem-driven visualization through design studies

- methodology matters
 - identify abstractions
 - crucial & difficult, iterative process
 - select appropriate idioms
 - or create new ones if necessary
- three examples
 - different domains
 - different methods

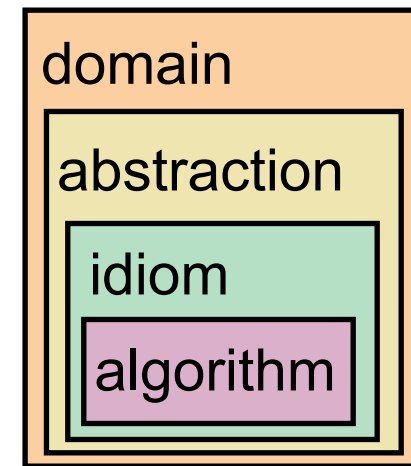

More information

- theoretical foundations: book (+ tutorial/course lecture slides)

<http://www.cs.ubc.ca/~tmm/vadbook>

Visualization Analysis and Design.
Munzner.
AK Peters Visualization Series.
CRC Press, 2014.

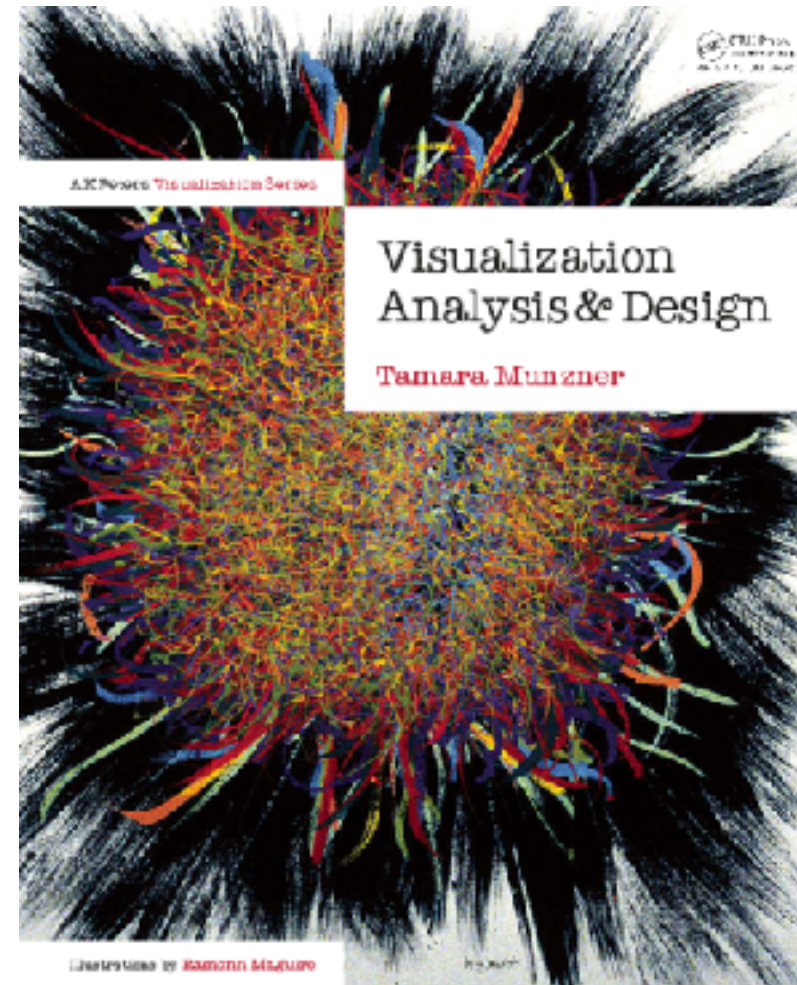

- papers, videos, software, talks, courses

<http://www.cs.ubc.ca/group/infovis>

<http://www.cs.ubc.ca/~tmm>

- this talk

<http://www.cs.ubc.ca/~tmm/talks.html#chinavis20>

 [@tamaramunzner](https://twitter.com/tamaramunzner)

